



QDE*

PROPORTIONAL COMPENSATED FLOW CONTROL VALVE

SERIES 11

SUBPLATE MOUNTING
ISO 6263-03
ISO 4401-05

p max 250 bar
Q max 80 l/min

OPERATING PRINCIPLE

- QDE* are proportional pressure-compensated flow control valves, with mounting surface according to ISO 6263-03 and ISO 4401-05. They operate as 2- or 3-port flow control valves, depending on the existence of the port P in the mounting surface.
- These valves are used for the flow control in branches of a hydraulic circuit or for the speed control of hydraulic cylinders.
- The valve can be controlled directly by a current control supply unit or by means of an electronic control unit, to exploit valve performance to the full (see point 13).
- QDE* valves are available in two sizes, for five flow adjustment ranges of up to 80 l/min.
- The valve body is zinc-nickel coated.

PERFORMANCES

(values measured with viscosity of 36 cSt at 50°C with electronic control unit)

	bar	QDE3				QDE5
		14	20	30	40	80
Maximum operating pressure	bar	250				250
Controlled flow (Q _B)	l/min	14	20	30	40	80
Max input flow (Q _A) (3-port)	l/min	40	50	40	50	90
Spring setting in pressure compensator	bar	4	8	4	8	8
Minimum pressure drop A > B	bar	10	22	10	22	22
Hysteresis	% of Q _{max}	< 6 %				
Repeatability	% of Q _{max}	< ± 1,5 %				< ± 2 %
Electrical characteristics		see point 5				
Fluid temperature range	°C	-20 / +60				
Fluid temperature range	°C	-20 / +80				
Fluid viscosity range	cSt	10 ÷ 400				
Fluid contamination degree		according to ISO 4406:1999 class 18/16/13				
Recommended viscosity	cSt	25				
Mass	kg	1,4			4,4	

HYDRAULIC SYMBOLS

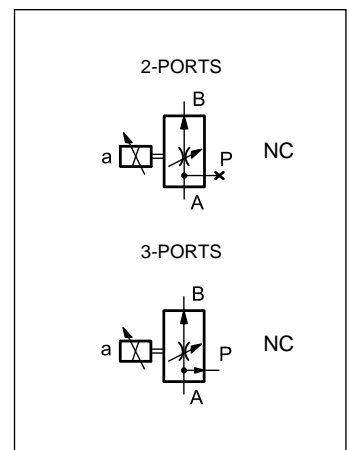



1 - IDENTIFICATION CODE

	Q	D	E		-		/	11		-			/	
--	----------	----------	----------	--	----------	--	----------	-----------	--	----------	--	--	----------	--

Flow control valve direct operated
Electric proportional control

Size: _____
3 = ISO 6263-03
5 = ISO 4401-05

Controlled flow: _____
QDE3 **QDE5**
14 = 14 l/min **80** = 80 l/min
20 = 20 l/min
30 = 30 l/min
40 = 40 l/min

Option: manual override (see at point 10)

Coil electrical connection:
K1 = plug for connector type EN 175301-803 (ex DIN 43650) (**standard**)
K7 = plug for connector type DEUTSCH DT04-2P male

D12 = Nominal solenoid voltage 12V DC
D24 = Nominal solenoid voltage 24V DC

Seals:
N = NBR seals (**standard**)
V = FPM seals for special fluids

Series no. (from 10 to 19 sizes and mounting dimensions remains unchanged)

NOTE: The zinc-nickel finishing on the valve body makes the valve suitable to ensure a salt spray resistance up to **240** hours. (test operated according to EN ISO 9227 standards and test evaluation operated according to UNI EN ISO 10289 standards).
For a salt spray resistance up to 600 hours order the high corrosion resistance version.

1.1 - QDE3: high corrosion resistance version

This version features the zinc-nickel coating on all exposed metal parts of the valve, making it resistant to exposure to the salt spray for **600** hours (test performed according to UNI EN ISO 9227 and assessment test performed according to UNI EN ISO 10289).

The coil are specific for this version, featuring a zinc-nickel surface treatment. The boot manual override (CM) is installed as standard in order to protect the solenoid tube.

Follow the identification code below to order it:

	Q	D	E	3	-		/	11		-			/		/	W7
--	----------	----------	----------	----------	----------	--	----------	-----------	--	----------	--	--	----------	--	----------	-----------

Choices as in standard identification code

Coil electrical connection _____
WK1 = plug for connector type EN 175301-803 (ex DIN 43650)
WK7 = plug DEUTSCH DT04-2P, for male connector type DEUTSCH DT06-2S.

Manual override: (see at point 10)
CM = manual override, boot protected (**standard**)
CK1 = knob manual override

2 - CONFIGURATIONS AND MOUNTING INTERFACE

The function of two- or three- port valve is obtained by realizing the mounting interface with holes according to ISO 6263-03 for QDE3 and with holes according to ISO 4401-05 for QDE5, without ever making the path T to reservoir, and making the path P only for three- port configuration. To use the QDE3 as two- port valve it is also possible to interpose an adapter plate with plug (code 0113388 and 0530384), to be ordered separately.

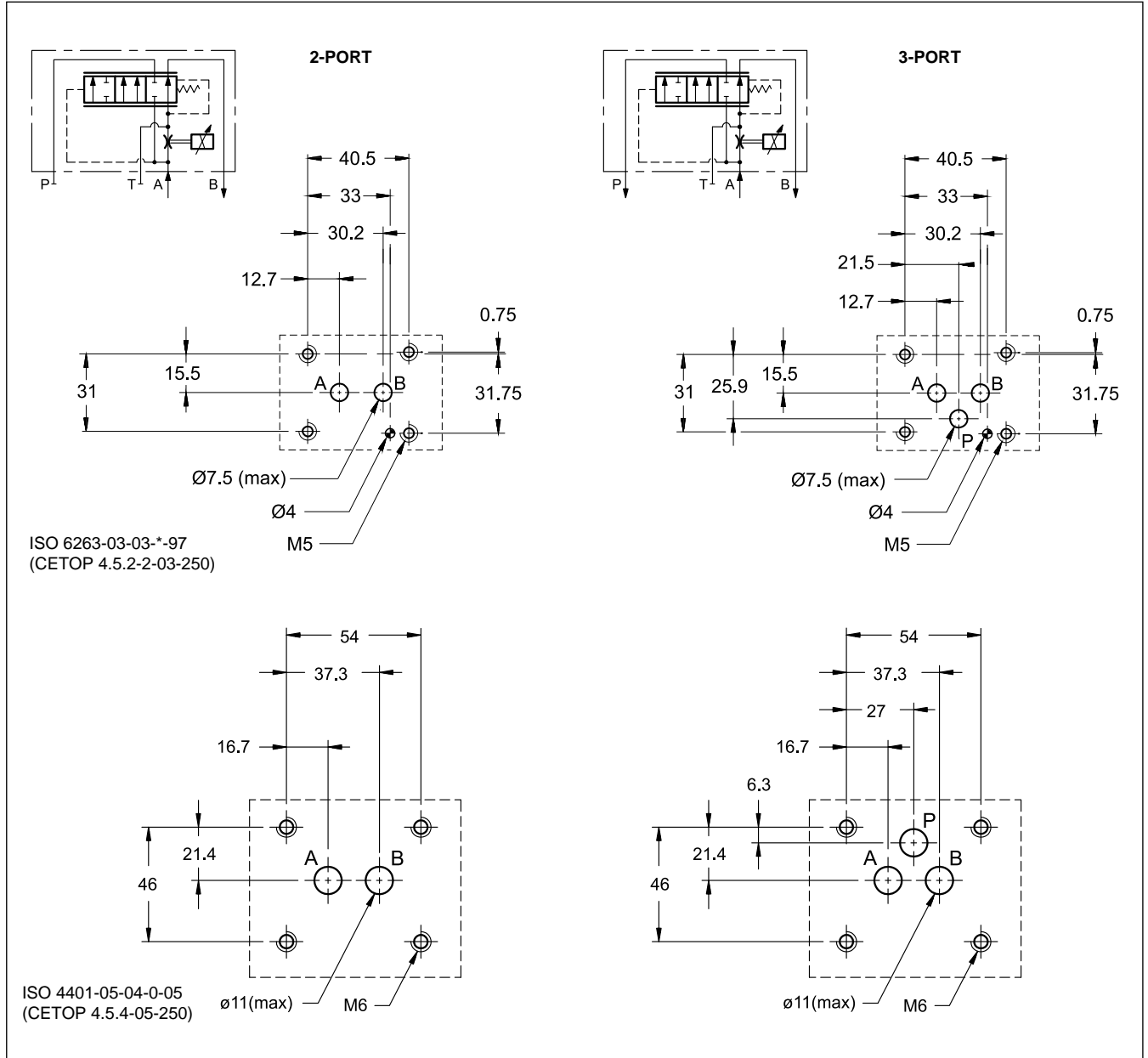

3 - CHARACTERISTIC CURVES QDE3

(obtained with viscosity of 36 cSt a 50°C)

3.1 - Two-port

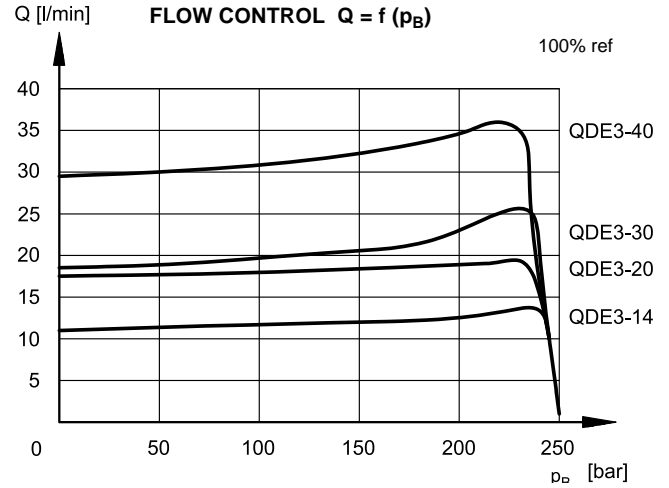
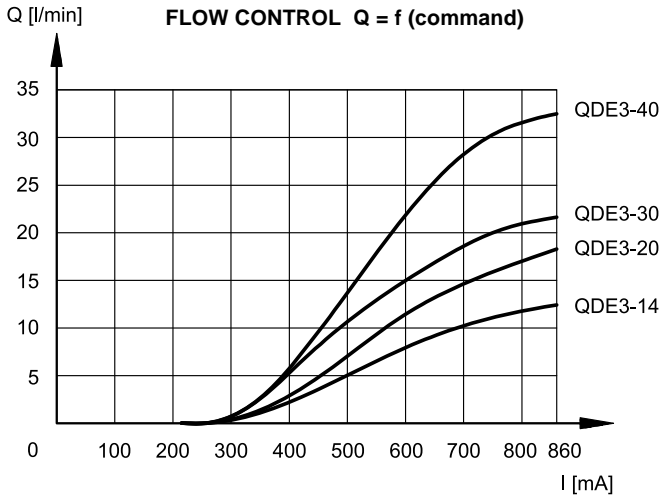

Typical flow rate characteristics A → B for controlled flow rate:
14 - 20 - 30 - 40 l/min in function of the current supplied to the solenoid (D24 version, maximum current 860 mA, PWM 100 Hz)

3.2 - Three-port

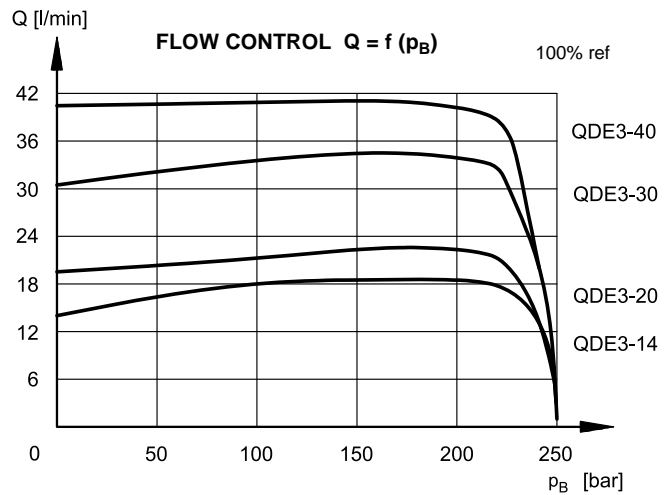
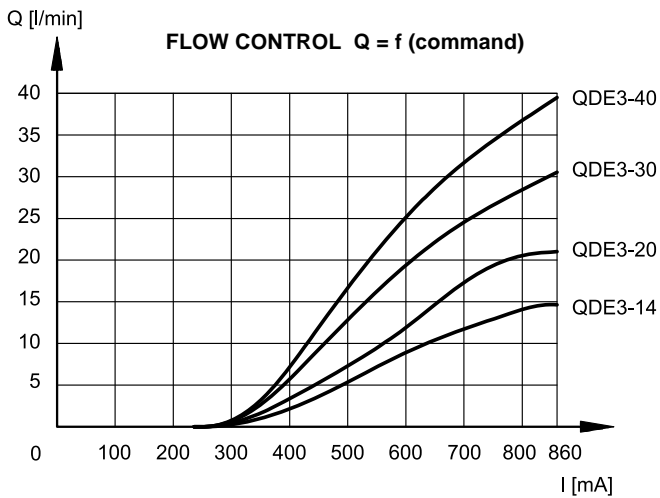

Typical flow rate characteristics A → B for controlled flow rate:
14 - 20 - 30 - 40 l/min in function of the current supplied to the solenoid (D24 version, maximum current 860 mA, PWM 100 Hz)

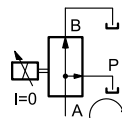
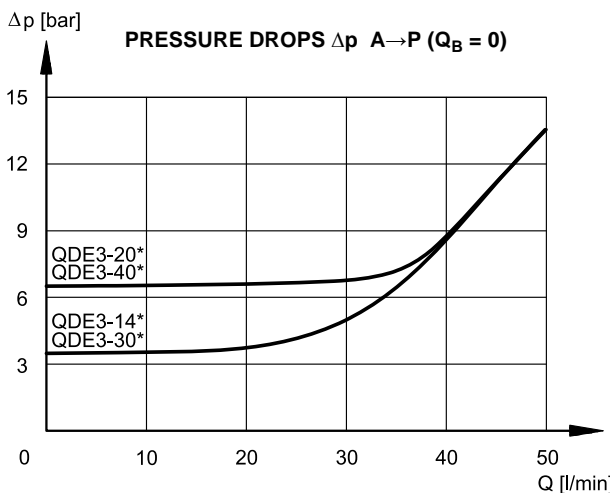

Pressure drops with flow A → P.
Obtained with $Q_B = 0$ (no current)

4 - CHARACTERISTIC CURVES QDE5

(obtained with viscosity of 36 cSt a 50°C)

4.1 - Two-port

Q [l/min] **FLOW CONTROL $Q = f(\text{command})$**

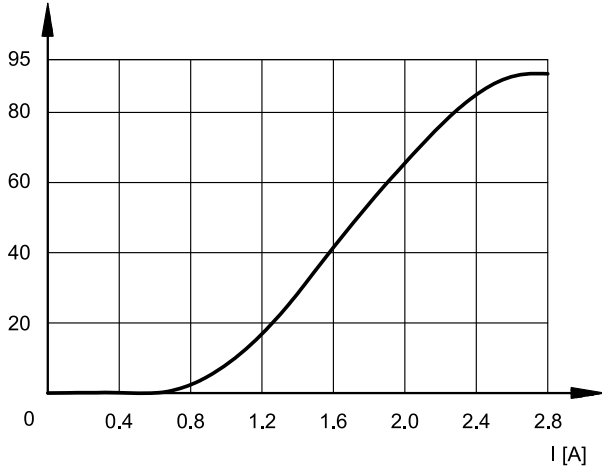

Typical flow rate characteristics A → B in function of the current supplied to the solenoid (D12 version, max current 2.8 A, PWM 100 Hz).

Q [l/min] **FLOW CONTROL $Q = f(p_B)$**

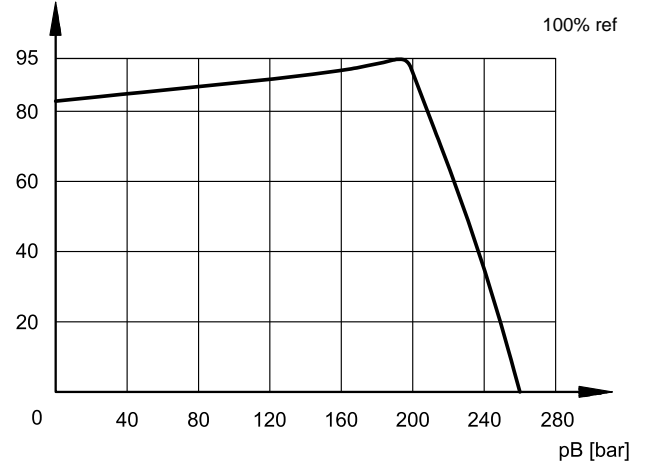

100% ref

4.2 - Three-port

Q [l/min] **FLOW CONTROL $Q = f(\text{command})$**

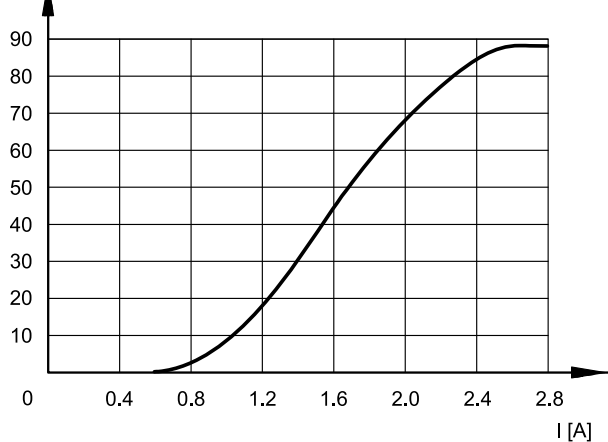

Typical flow rate characteristics A → B in function of the current supplied to the solenoid (D12 version, max current 2.8 A, PWM 100 Hz).

Q [l/min] **FLOW CONTROL $Q = f(p_B)$**

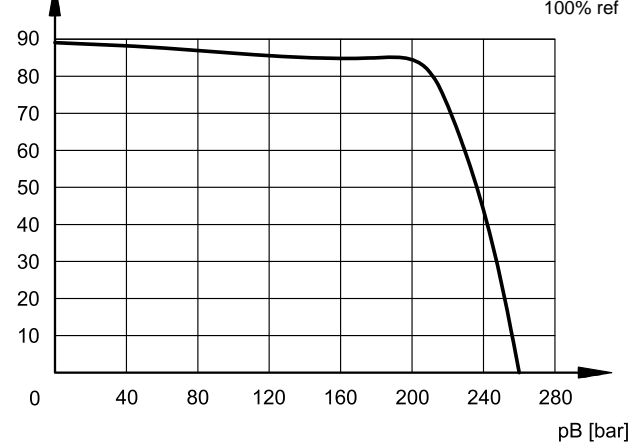

100% ref

Δp [bar] **PRESSURE DROPS Δp A → P ($Q_B = 0$)**

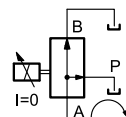
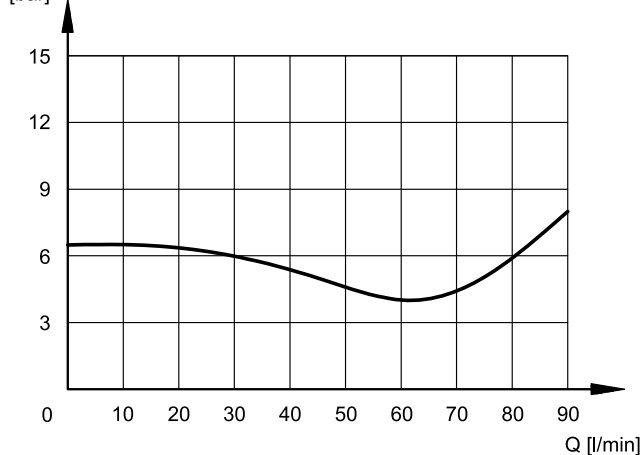

Pressure drops with flow A → P.
 Obtained with $Q_B = 0$ (no current)



5 - ELECTRICAL CHARACTERISTIC

Proportional solenoid

The proportional solenoid comprises two parts: tube and coil.

The tube, screwed to the valve body, contains the armature which is designed to maintain friction to a minimum thereby reducing hysteresis.

The coil is mounted on the tube secured by means of a lock nut and can be rotated through 360° depending on installation clearances.

DUTY CYCLE	100%
ELECTROMAGNETIC COMPATIBILITY (EMC)	According to 2014/30/EU
CLASS OF PROTECTION: coil insulation (VDE 0580) Impregnation	class H class F

		QDE3		QDE5	
NOMINAL VOLTAGE	V DC	12	24	12	24
RESISTANCE (at 20°C)	ohm	4,4	18,6	3	12
NOMINAL CURRENT	A	1,88	0,86	2,8	1,6
PWM FREQUENCY	Hz	100		100	

Protection from atmospheric agents IEC 60529

The IP protection degree is guaranteed only with both valve and connectors of an equivalent IP grade correctly connected and installed.

electric connection	electric connection protection	whole valve protection
QDE3		
K1 EN 175301-803	IP65	IP65
K7 DEUTSCH DT04 male	IP65/IP67	
WK1 EN 175301-803	IP66	IP66
WK7 DEUTSCH DT04 male	IP66/IP68/IP69 IP69K*	IP66/IP68/IP69 IP69K*

QDE5		
K1 EN 175301-803	IP65	IP65
K7 DEUTSCH DT04 male	IP65/IP67	

6 - STEP RESPONSE

(values measured with viscosity of 36 cSt at 50°C with electronic control unit)

Step response is the time taken for the valve to reach 90% of the set flow value following a step change of reference signal.

The table illustrates typical response times with $\Delta p = 8$ bar.

REFERENCE SIGNAL STEP	0 → 100%
Step response [ms]	< 70

7 - ELECTRIC CONNECTIONS

Connectors for K1 and WK1 connections are always delivered together with the valve.

7.1 - QDE3

connection for EN 175301-803
(ex DIN 43650) connector
code **K1 (standard)**
code **WK1 (W7 version)**

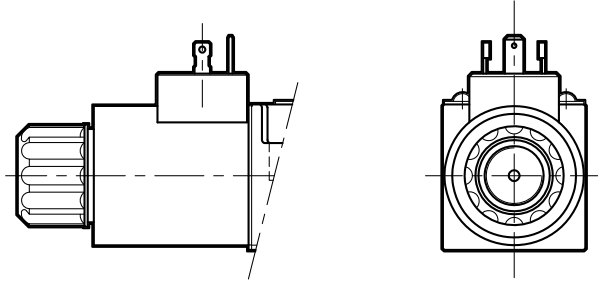

connection for
DEUTSCH DT06-2S male connector
code **K7**

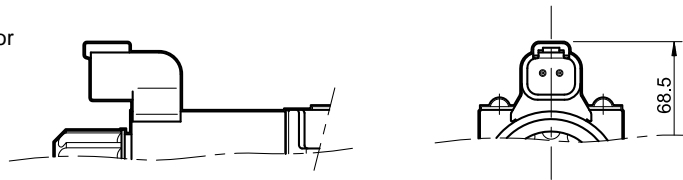

connection for
DEUTSCH DT06-2S male connector
code **WK7 (W7 version)**

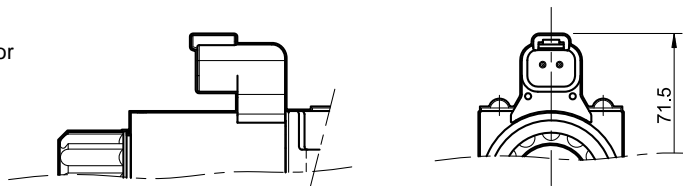

7.2 - QDE5

connection for EN 175301-803
(ex DIN 43650) connector
code **K1 (standard)**

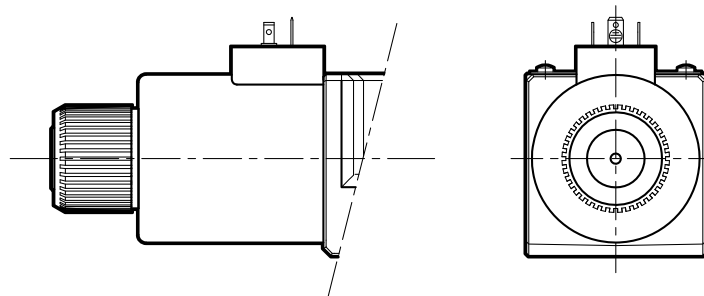

connection for
DEUTSCH DT06-2S male connector
code **K7**

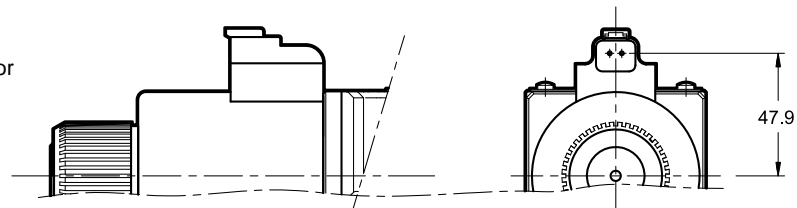

8 - QDE3 OVERALL AND MOUNTING DIMENSIONS

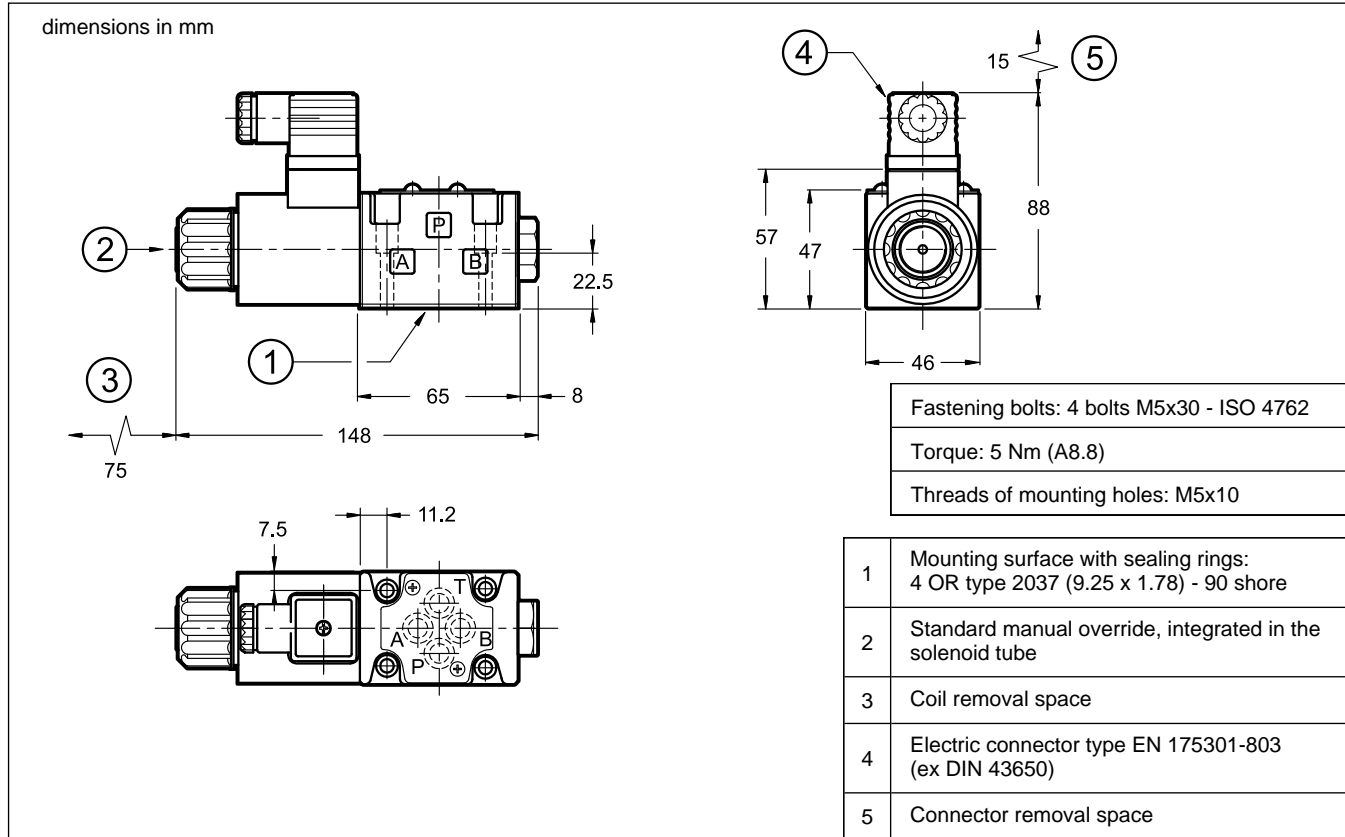

9 - QDE5 OVERALL AND MOUNTING DIMENSIONS

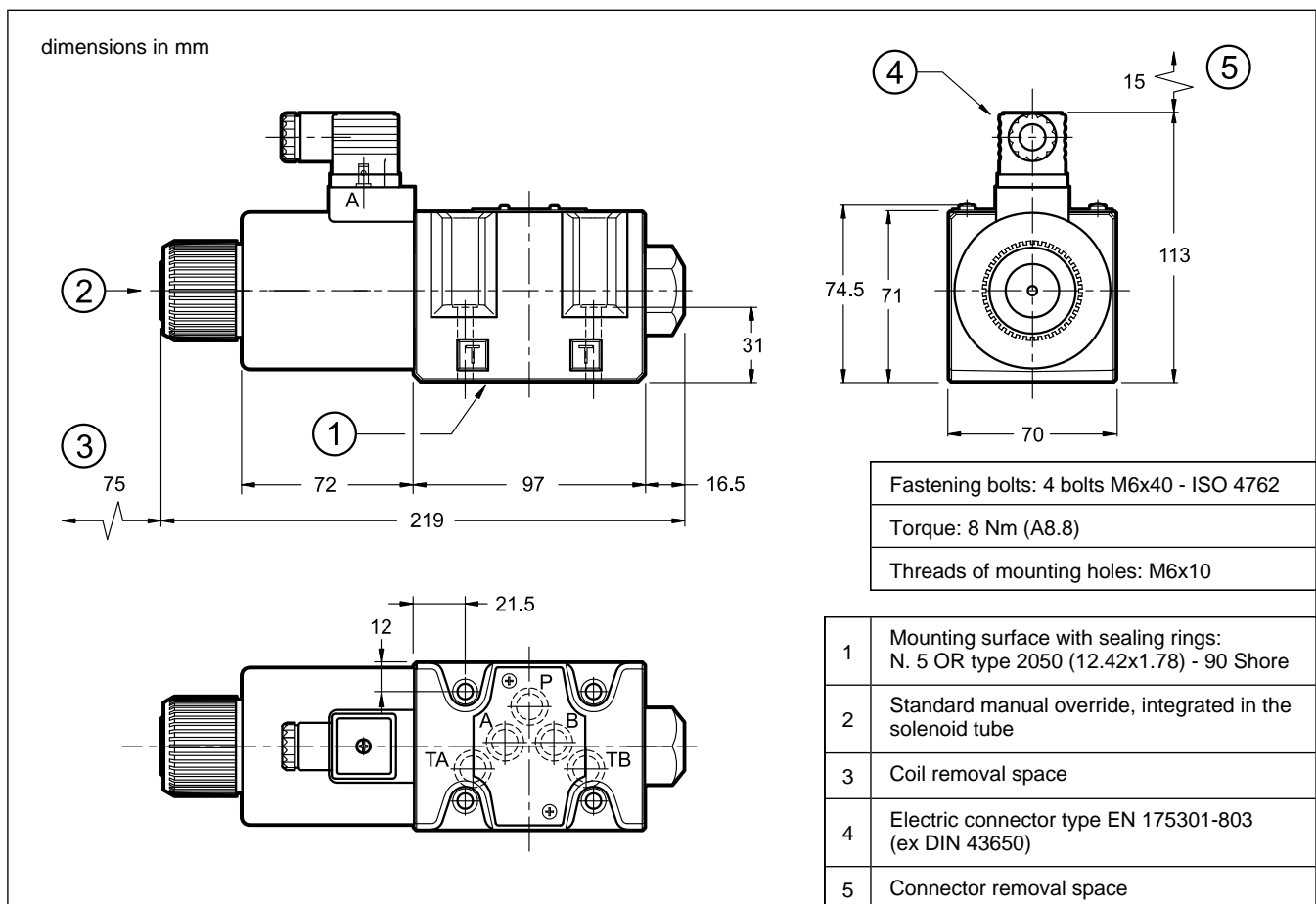

10 - MANUAL OVERRIDE

Standard valves have the pin for the manual operation integrated in the solenoid tube. The operation of this override must be executed with a suitable tool, minding not to damage the sliding surface.

For QDE3 are available:

- **CM**: manual override boot protected (mandatory for WK1 coils).
- **CK1** version, knob.

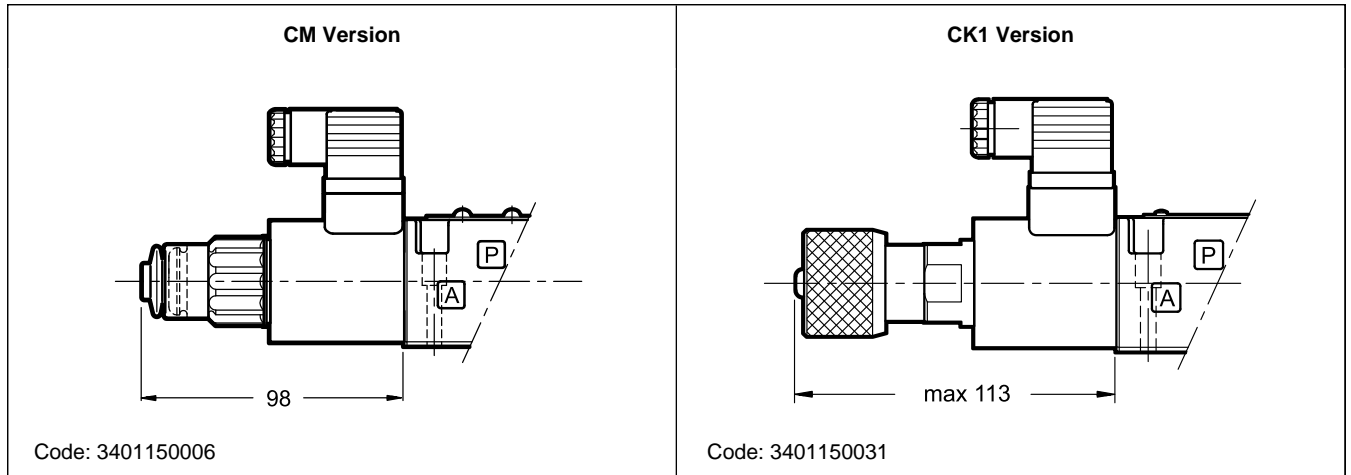

For QDE5 only available:

- **CK** version, knob. When the set screw is screwed and its point is aligned with the edge of the knob, tighten the knob till it touches the spool: in this position the override is not engaged and the valve is de-energized. After adjusting the override, tighten the set screw in order to avoid the knob loosening.

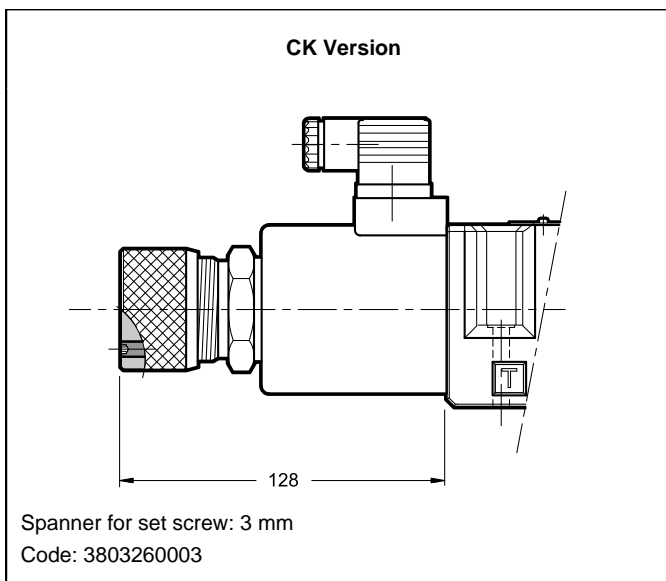

11 - HYDRAULIC FLUIDS

Use mineral oil-based hydraulic fluids HL or HM type, according to ISO 6743-4. For these fluids, use NBR seals (code N). For fluids HFDR type (phosphate esters) use FPM seals (code V). For the use of other kinds of fluid such as HFA, HFB, HFC, please consult our technical department. Using fluids at temperatures higher than 80 °C causes a faster degradation of the fluid and of the seals characteristics.

The fluid must be preserved in its physical and chemical characteristics.

12 - INSTALLATION

QDE* valves can be installed in any position without impairing correct operation. Ensure that there is no air in the hydraulic circuit.

Valves are fixed by means of screws or tie rods on a flat surface with planarity and roughness equal to or better than those indicated in the relative symbols.

If minimum values are not observed fluid can easily leak between the valve and support surface.

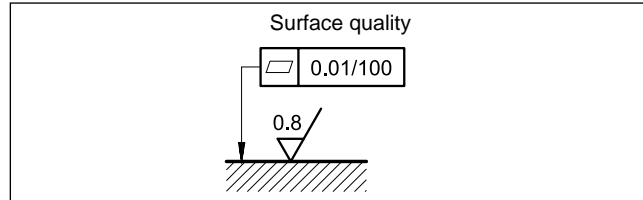

13 - ELECTRONIC CONTROL UNITS

QDE3

EDM-M111	24V DC solenoids	rail mounting DIN EN 50022	see catalogue 89 252
EDM-M141	12V DC solenoids		
EWM-A-PV	12V / 24V DC software config.		see catalogue 89 620

QDE5

EDM-M131	24V DC solenoids	rail mounting DIN EN 50022	see catalogue 89 252
EDM-M151	12V DC solenoids		
EWM-A-PV	12V / 24V DC software config.		see catalogue 89 620

	<p>DIPLOMATIC MS Spa via Mario Re Depaolini, 24 20015 Parabiago (MI) Italy T +39 0331 895111 E vendite.ita@duplomatic.com sales.exp@duplomatic.com duplomaticmotionsolutions.com</p>
--	--