



## INDUSTRIAL HYDRAULICS

**PRODUCT OVERVIEW**



# ABOUT THIS GUIDE

This guide is intended for a smart overview of our industrial hydraulics and let you find quickly the product you need.

Data sheet ref.

Main characteristics, available versions and options are shown together for quick comparison.

A brief description of the features follows.

The highlighted letter that precedes the description is the same letter that identifies the option in the identification code, in the data sheet, for an easy reference.

Not all the options are available for all versions: always verify technical data, details and availability in the technical data sheet.

**MODEL CODE** GPA\* - external gear

**CATALOGUE** 11 102

PUMP SIZE	DISPLACEMENT [cm <sup>3</sup> /rev]	FLOW RATE at 1500 rpm [l/min]	CONTINUOUS OPERATING PRESSURE [bar]	MAX ROTATION SPEED [rpm]
<b>GPA1</b>				
090	1	1.5	250	4000
095	1.5	2.2	260	
099	1.9	2.9		
025	2.5	3.8	240	
031	3.1	4.7		
038	3.8	5.7	200	
047	4.7	7.1		
053	5.3	8.0	180	
063	6.3	9.5		
075	7.5	11.3	3500	
<b>GPA2</b>				
045	4.5	6.8	250	4000
065	6.5	9.7		
082	8.2	12.3		
113	11.3	16.9	200	3500
146	14.6	21.9		
169	16.9	25.4		
201	20.1	30.2	250	3000
220	22	33		
252	25.2	37.8	210	2500
280	28	42		
317	31.7	47.6	180	2000
330	33	49.5		
<b>GPA3</b>				
220	22	33	250	3000
270	27	40.5		
330	33	49.5	240	2500
390	39	58.5		
450	45	67.5	210	2000
480	48	72		
520	52	78	190	1500
630	63	94.5		

**ROTATION** **L** clockwise - **R** counterclockwise

**MOUNTING FLANGE\* SHAFT END:** 4 holes and tapered shaft end 1:8

**HYDRAULIC CONNECTIONS:** F1 european flanged - B BSP threaded ports

OTHER: see catalogue for 15/10/18 and 18/11/11 PUMPS

You can find data sheets always up-to-date in various languages by scanning this QR code with your smartphone



or on our webpages at:

[www.diplomaticmotionsolutions.com/en/new-products.html](http://www.diplomaticmotionsolutions.com/en/new-products.html)

The content of this *Product Overview* is provided for information only and without responsibility. Diplomatic MS makes no representations about misprint, completeness or timeliness of the information in this literature. Diplomatic MS may, in its sole discretion, revise the information contained herein at any time without notice.

The reproduction of the contents of this manual, in whole or in part, without written permission of Diplomatic MS Spa, is prohibited.



# INDUSTRIAL

PUMPS .....	2
VALVES, PRESSURE .....	10
VALVES, FLOW .....	12
VALVES, CARTRIDGES .....	13
VALVES, DIRECTIONAL CONTROL .....	14
VALVES, CHECK .....	23
LOGIC ELEMENTS .....	24
VALVES, STACK .....	26
VALVES, PROPORTIONAL .....	30
CYLINDERS.....	40
ELECTRONICS .....	43
ACCESSORIES.....	46
HYBRID SERIES .....	50

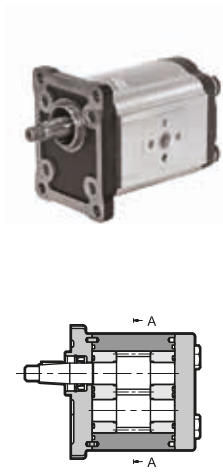

MODEL CODE **GPA\* - external gear**

CATALOGUE		11 102		
PUMP SIZE	DISPLACEMENT	FLOW RATE at 1500 rpm	CONTINUOUS OPERATING PRESSURE	MAX ROTATION SPEED
	[cm <sup>3</sup> /rev]	[l/min]	[bar]	[rpm]

**GPA1**

010	1	1.5	250	4000
015	1.5	2.2	260	
019	1.9	2.9		
025	2.5	3.8		
031	3.1	4.7		
038	3.8	5.7	240	
047	4.7	7.1		
053	5.3	8.0	230	3500
063	6.3	9.5	180	
075	7.5	11.3		

**GPA2**

045	4.5	6.8	260	4000
065	6.5	9.7		
082	8.2	12.3		
113	11.3	16.9		3500
146	14.6	21.9		
169	16.9	25.4		3200
201	20.1	30.2	250	3000
220	22	33		2700
252	25.2	37.8	210	2500
280	28	42	200	2200
317	31.7	47.6	180	2000

**GPA3**

220	22	33	250	3000
270	27	40.5		
330	33	49.5	240	
390	39	58.5		
440	44	66	230	2500
480	48	72	210	
520	52	78		
610	61	91.5	190	

**FEATURES ++**

ROTATION: **R** clockwise - **L** counterclockwise

MOUNTING FLANGE+SHAFT END: 4 holes and tapered shaft end 1:8

HYDRAULIC CONNECTIONS: **FE** european flanged - **B** BSP threaded ports

OTHER: see catalogue for **TANDEM** and **MULTIPLE PUMPS**

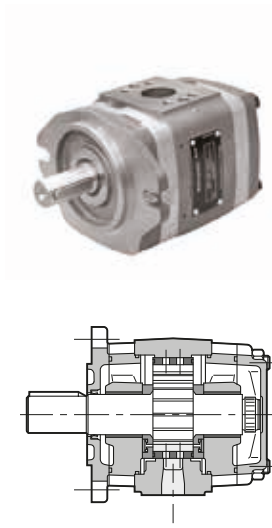

## MODEL CODE

## IGP\* - internal gear

## CATALOGUE

## 12 100

PUMP SIZE	DISPLACEMENT	MAX FLOW RATE at 1500 rpm	MAX OPERATING PRESSURE	MAX ROTATION SPEED
	[cm <sup>3</sup> /rev]	[l/min]	[bar]	[rpm]
<b>IGP3</b>				
003	3,6	5,4	330	3600
005	5,2	7,8		
006	6,4	9,6		
008	8,2	12,3		
010	10,2	15,3		
<b>IGP4</b>				
013	13,3	19,9	330	3600
016	15,8	23,7		3400
020	20,7	31,0		3200
025	25,4	38,1	300	3000
032	32,6	48,9	250	2800
<b>IGP5</b>				
032	33,1	49,6	315	3000
040	41,0	61,5		2800
050	50,3	75,4	280	2500
064	64,9	97,3	230	2200
<b>IGP6</b>				
064	64,1	96,1	300	2600
080	80,7	121,0	280	2400
100	101,3	151,9	250	2100
125	126,2	189,3	210	1800
<b>IGP7</b>				
125	125,8	188,7	300	2200
160	160,8	241,2	280	2000
200	202,7	304,0	250	1800
250	251,7	377,5	210	

## ■ FEATURES ++

ROTATION: **R** clockwise - **L** counterclockwise

MOUNTING FLANGE: **0** SAE 2 - **1** SAE 4 (IGP7 only). SHAFT END: cylindrical keyed

HYDRAULIC CONNECTIONS: flanged SAE J518 c code 61

OTHER: see catalogue for **DOUBLE PUMPS**

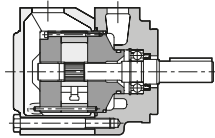

MODEL CODE

**DF\* - fixed displacement**

CATALOGUE

**13 100**

PUMP SIZE	DISPLACEMENT	MAX FLOW RATE at 1500 rpm	MAX OPERATING PRESSURE	MAX ROTATION SPEED
	[cm <sup>3</sup> /rev]	[l/min]	[bar]	[rpm]

**DFP1**

05	18,0	26,1	210	1800
08	27,4	39,4		
11	36,4	52,6		
12	39,5	58,7	160	
14	45,9	69,6	140	

**DFP2**

12	40,1	58,8	175	1800
14	45,4	65,7		
17	55,2	80,2		
19	60,1	88,7		
21	67,5	99,8		

**DFP3**

21	69,0	101,4	175	1800
25	81,6	120,1		
30	97,7	121,4		
35	112,7	167,2		
38	121,6	177,3		

**DFP4**

42	138,6	203,4	175	1800
47	153,5	222,7		
50	162,2	234,0		
57	183,4	267,0		
60	193,4	185,0		

**FEATURES ++**

TYPE: **P** single pump - **DP** double pump - **C** cartridge for single pump or front pump - **CC** cartridge for rear pump

ROTATION: **R** clockwise - **L** counterclockwise

MOUNTING FLANGE: SAE J744

SHAFT END: cylindrical keyed. Other upon request

HYDRAULIC CONNECTIONS: SAE J518 flanged.

OTHER: see catalogue for **OUTLET PORTS POSITION**

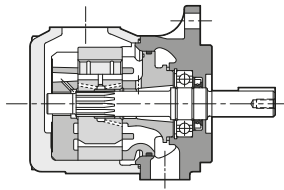

## MODEL CODE

## FV6 - fixed displacement

## CATALOGUE

## 13 110

PUMP SIZE	DISPLACEMENT	MAX FLOW RATE at 1500 rpm	MAX OPERATING PRESSURE	MAX ROTATION SPEED
	[cm <sup>3</sup> /rev]	[l/min]	[bar]	[rpm]

## FV6C

03	10,8	16,2	240	2800
05	17,2	25,8		
06	21,3	31,9		
08	26,4	39,6		
10	34,1	51,1		
12	37,1	55,6		
14	46,0	69,0		
17	58,3	87,4		
20	63,8	95,7		
22	70,3	105,4		
25	79,3	118,9		
28	88,8	133,2		
31	100,0	150,0	160	2500

## FV6D

14	47,6	71,4	210	2500
17	58,2	87,3		
20	66,0	99,0		
24	79,5	119,3		
28	89,7	134,6		
31	98,3	147,5		
35	111,0	166,5		
38	120,3	180,5		
42	136,0	204,0		
45	145,7	218,6		
50	158,0	237,0	160	2200

## FV6E

42	132,3	198,5	210	2200
45	142,4	213,6		
50	158,5	237,8		
52	164,8	247,2		
57	179,8	269,6		
62	196,7	295,1		
66	213,3	320,0		
72	227,1	340,0		
85	269,0	403,0	80	2000

## ■ FEATURES ++

PUMP SIZE: **C** from 10.8 to 100 cm<sup>3</sup>/rev - **D** from 47.6 to 158 cm<sup>3</sup>/rev - **E** from 132.3 to 269 cm<sup>3</sup>/rev

ROTATION: **R** clockwise - **L** counterclockwise

MOUNTING FLANGE: SAE B J744, SAE C J744

SHAFT END: cylindrical keyed SAE, non-SAE, involute spline SAE, non-SAE. See catalogue.

HYDRAULIC CONNECTIONS: SAE J518 flanged.

**FV6, FV67 DOUBLE AND TRIPLE** pumps available.

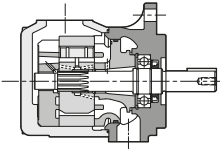

MODEL CODE

**FV7\*S - fixed displacement**

CATALOGUE

**13 120**

PUMP SIZE	DISPLACEMENT	MAX FLOW RATE at 1500 rpm	MAX OPERATING PRESSURE	MAX ROTATION SPEED
	[cm <sup>3</sup> /rev]	[l/min]	[bar]	[rpm]
<b>FV7BS</b>				
02	5,8	8,7	320	3600
03	9,8	14,7		
04	12,8	19,2		
05	15,9	23,9		
06	19,8	29,7		
07	22,5	33,8		
08	24,9	37,4		
10	31,8	47,7		
12	41,0	61,5	275	3000
15	50,0	75,0	240	

**FV7DS**

14	44,0	66,0	250	3000
17	55,0	82,5		
20	66,0	99,0		
22	70,3	105,5		
24	81,1	121,7		
28	90,0	135,0		
31	99,2	148,8		
35	113,4	170,1		
38	120,6	180,9	2800	
42	137,5	206,3		230

**FEATURES ++**

PUMP SIZE: **B** from 5.8 to 50 cm<sup>3</sup>/rev - **D** from 44 to 137.5 cm<sup>3</sup>/rev

ROTATION: **R** clockwise - **L** counterclockwise; MOUNTING FLANGE: SAE B J744, SAE C J744,

SHAFT END: cylindrical keyed SAE, non SAE, involute spline SAE. See catalogue.

HYDRAULIC CONNECTIONS: SAE J518 flanged.

MODEL CODE

**RV1D - direct variable displacement**

CATALOGUE

**14 101**

PUMP SIZE	DISPLACEMENT	MAX FLOW RATE at 1500 rpm	MAX OPERATING PRESSURE	MAX ROTATION SPEED
	[cm <sup>3</sup> /rev]	[l/min]	[bar]	[rpm]
<b>RV1D</b>				
016	17,0	25,5	120	1800
020	21,0	31,5	100	
025	26,0	39,0		
032	33,0	49,5	100	1500
040	42,0	63,0		
050	51,0	76,5		
063	63,0	94,5		
080	80,0	120,0	90	
100	100,0	150,0		
120	123,0	184,5		

**FEATURES ++**

ROTATION: clockwise. MOUNTING: **5** 4-holes ISO 3019/2 - **9** 4-holes rectangular type (for RV1D-016 only).

SHAFT END: **5** cylindrical keyed - **7** conical keyed

HYDRAULIC CONNECTIONS: **B** BSP threaded - **S** SAE flange

PRESSURE COMPENSATOR: mechanical, direct

See catalogue for **MULTIPLE PUMPS**

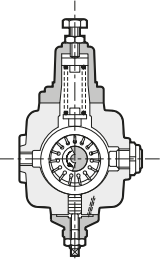
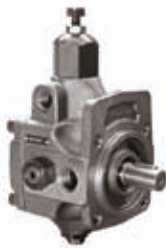



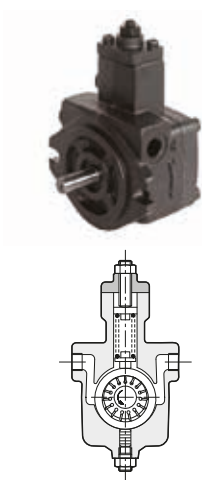

MODEL CODE

**PVE - direct variable displacement**

CATALOGUE

**14 110**

PUMP SIZE	DISPLACEMENT	MAX FLOW RATE at 1800 rpm	MAX OPERATING PRESSURE	MAX ROTATION SPEED
	[cm <sup>3</sup> /rev]	[l/min]	[bar]	[rpm]
<b>PVE</b>				
006	6,6	12,0	70	1800
011	11,1	20,0		
016	16,6	30,0		
023	22,2	40,0		

**■ FEATURES ++**

ROTATION: clockwise. MOUNTING FLANGE: **9** rectangular shape 4 holes - **0** SAE J744 2 holes  
 SHAFT END: cylindrical keyed SAE-J744. HYDRAULIC CONNECTIONS: BSPP threaded  
 PRESSURE COMPENSATOR: mechanical, direct. **PC2** up to 35 bar - **PC3** up to 70 bar

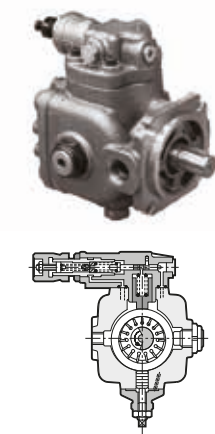

MODEL CODE

**RV1P - variable displacement, hydraulic op. compensator**

CATALOGUE

**14 201**

PUMP SIZE	DISPLACEMENT	FLOW RATE at 1500 rpm	MAX OPERATING PRESSURE	MAX ROTATION SPEED
	[cm <sup>3</sup> /rev]	[l/min]	[bar]	[rpm]
<b>RV1P</b>				
016	17,0	25,5	250	1800
020	21,0	31,5		
025	26,0	39,0		
032	33,0	49,5		1500
040	42,0	63,0		
050	51,0	76,5		
063	63,0	94,5		
080	80,0	120,0	210	
100	100,0	150,0		
120	123,0	184,5		

**■ FEATURES ++**

ROTATION: clockwise.  
 MOUNTING FLANGE: **5** 4 bolts ISO 3019/2 - **7** 4 holes rectangular type (for RV1P-016 only)  
 SHAFT END: **5** cylindrical keyed - **9** conical keyed.  
 HYDRAULIC CONNECTIONS: **B** BSP threaded - **S** SAE flange  
 PRESSURE COMPENSATOR: **PC** hydraulic pressure control - **PCX** dual pressure, one of which is fixed  
 See catalogue for **MULTIPLE PUMPS**

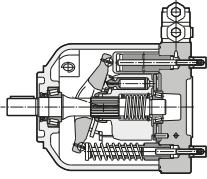

## MODEL CODE

## VPPM - medium pressure

## CATALOGUE

## 16 100

PUMP SIZE	MAX DISPLACEMENT	FLOW RATE at 1500 rpm	MAX OPERATING PRESSURE	MAX ROTATION SPEED
	[cm <sup>3</sup> /rev]	[l/min]	[bar]	[rpm]

## VPPM

029	29	43,5	280	3000
046	46	69,0		2600
073	73	109,5		2200
087	87	131,9	250	1850

## ■ FEATURES ++

ROTATION: **R** clockwise - **L** counterclockwise

MOUNTING FLANGE: **5** ISO 3019/2 - **0** SAE J744 2 holes

SHAFT END: **5** cylindrical keyed ISO 3019-2 - **0** cylindrical keyed SAE J744 - **1** SAE J744 splined

HYDRAULIC CONNECTIONS: **S** SAE flange w. metric bolts suction/delivery, drainage BSP threaded

**T** SAE flange w. UNF bolts suction/delivery, drainage UNF threaded

CONTROLS: **PC** pressure - **PCR** remote pressure control - **PCX** with external pressure control

devices - **PQC** pressure and flow rate - **PQCE5** integrated proportional flow and pressure control

**PQNC** power - **PQNCE5** power, with integrated proportional flow and pressure control

OTHER: see catalogue for **MULTIPLE PUMPS**

## MODEL CODE

## VPPL - low-medium pressure

## CATALOGUE

## 16 200

PUMP SIZE	MAX DISPLACEMENT	FLOW RATE at 1500 rpm	MAX OPERATING PRESSURE	MAX ROTATION SPEED
	[cm <sup>3</sup> /rev]	[l/min]	[bar]	[rpm]

## VPPL

008	8	12	210	2000
016	16	24		
022	22	33		
036	36	54		
046	46	69		
070	70	105	280	1800
100	100	150		

## ■ FEATURES ++

ROTATION: clockwise

MOUNTING FLANGE: **0** SAE-2 (VPPL 008, 016, 022, 036, 046) - **1** SAE-4 (VPPL 070, 100)

SHAFT END: cylindrical keyed SAE-J744

HYDRAULIC CONNECTIONS: **S** SAE flange w. metric bolts suction/delivery, drainage BSP threaded

**B** BSP threaded ports (VPPL-008 only)

CONTROLS: **PC5**, **PC6** pressure - **PCR** remote pressure control - **PCX5**, **PCX6** with external

pressure control devices - **PQC** pressure and flow rate

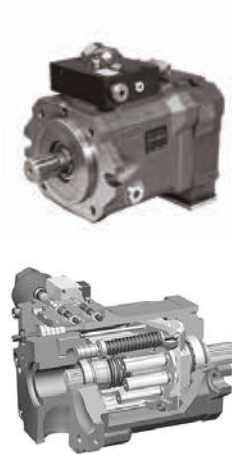

## MODEL CODE

**HPR - high pressure**

## CATALOGUE

**16 300**

PUMP SIZE	MAX DISPLACEMENT	FLOW RATE at 1500 rpm	MAX OPERATING PRESSURE	MAX ROTATION SPEED
	[cm <sup>3</sup> /rev]	[l/min]	[bar]	[rpm]
<b>HPR</b>				
055	55,0	82,5	420	2700
075	75,9	113,9		2500
105	105,0	157,5		2500
135	135,7	203,5		2350
165	165,6	248,2		2200
210	210,1	315,5		2100
280	281,9	422,9		2000

**FEATURES ++**

ROTATION: **R** clockwise

MOUNTING FLANGE: SAE J744 2 holes; SAE J744 4 holes for HPR210 and 280

SHAFT END: SAE J744 splined

HYDRAULIC CONNECTIONS: flange fittings - SAE 3000 suction / SAE 6000 pressure

POWER TAKE-OFF: **A00** SAE A flange, no shaft coupling (single pump, std).

See catalogue for power take-off / through drive shaft available couplings.

CONTROLS: **LP6** load sensing w. pressure cut-off - **TL2** load sensing w. power control (HPR105, 135, 210 and 280 only) - **ET6** continuous displacement control w. power limiter and pressure cut-off (HPR105, 135, 210 and 280 only) **D12K2** or **D24K2** available coils.

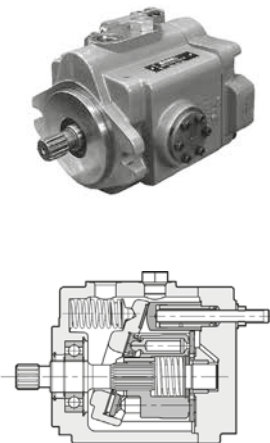

## MODEL CODE

**AP1V - medium-high pressure**

## CATALOGUE

**16 500**

PUMP SIZE	MAX DISPLACEMENT	FLOW RATE at 1500 rpm	MAX OPERATING PRESSURE	MAX ROTATION SPEED
	[cm <sup>3</sup> /rev]	[l/min]	[bar]	[rpm]
<b>AP1V</b>				
015	14,9	22,4	280	3000
021	20,9	31,6		
035	35,3	52,9		
045	45,2	67,8		
065	65,9	98,9		

**FEATURES ++**

ROTATION: **R** clockwise - **L** counterclockwise

MOUNTING FLANGE: SAE J744 2 holes

SHAFT END: **0** cylindrical keyed SAE J744 - **1** SAE J744 splined

HYDRAULIC CONNECTIONS: **R** SAE flanges on rear - **S** SAE flanges on side;

for AP1V-015 and AP1V-021: **R** BSP ports on rear - **S** BSP ports on side

POWER TAKE-OFF: **000** no shaft coupling (single pump, std). PTO available for pumps AP1V-035, 045 and 065 with side ports only. See catalogue.

CONTROLS: **PC** pressure - **PCR** remote pressure control - **PQC** pressure and flow rate

# PRESSURE VALVES

## IN-LINE

## SUBPLATE

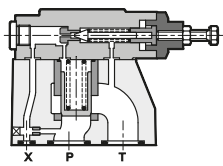

MODEL CODE	CD1-W	RM2-W	RM3-W	RQ5-W	RQM5-W	RQ7-W	RQM7-W
CATALOGUE	21 200	21 210	21 210	21 220	21 230	21 220	21 230
SIZE (ND)	6	8	10	15		25	
port THREAD	1/4" NPT	3/8" BSP	1/2" BSP	P: 3/4" BSP	T: 1" BSP	P: 1 1/4" BSP	T: 1 1/2" BSP
TYPE	piloting	relief	relief	relief	relief venting	relief	relief venting
p max	350 bar						
Q max	3 l/min	50 l/min	75 l/min	250 l/min		400 l/min	
<b>PRESSURE ADJ. RANGE</b>							
up to 70 bar	■	■	■	■	■	■	■
up to 140 bar	■	■	■				
up to 210 bar	■	■	■	■	■	■	■
up to 350 bar	■	■	■	■	■	■	■

### FEATURES ++

VENTING TYPE: **A, B, C, D, G** (RQM\* only)

OPTIONS: **M** adjustment knob; **CM** boot (RQM\* only)

COILS: power supply **DC** 12V, 24V, 48V, 110V, 220V; **AC** 12V, 24V, 48V, 110V, 220V; F110, F220 - DIN 43650 connector

MODEL CODE	RQ3-P	RQM3-P	RQ5-P	RQM5-P	RQ7-P	RQM7-P
CATALOGUE	21 300	21 310	21 300	21 310	21 300	21 310
SIZE (ND)	10		25		32	
SIZE ISO 6264	06		08		10	
TYPE	relief	relief venting	relief	relief venting	relief	relief venting
p max	350 bar					
Q max	200 l/min		400 l/min		500 l/min	

### FEATURES ++

EXPLOSION PROOF **RQM\*K\*-P** see catalogue 21 515

VENTING TYPE: **A, B, C, D, G** (RQM\* only)

COILS: power supply **DC** 12V, 24V, 48V, 110V, 220V; **AC** 12V, 24V, 48V, 110V, 220V; F110, F220 - DIN 43650 connector

PRESSURE ADJ. RANGE: **3** up to 70 bar - **5** up to 210 bar - **7** up to 350 bar

OPTIONS: **M** adjustment knob; **CM** boot (solenoid op. only)

### VENTING TYPE

**A** venting with de-energized solenoid - **B** venting with energized solenoid

**C** two pressure settings, highest with energized solenoid - **D** two pressure settings, venting with de-energized solenoid

**G** three pressure settings, highest with de-energized solenoid

### SYMBOLS

RM\*

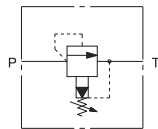

RQ\*

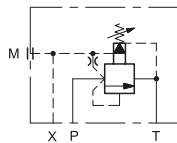

RQM\*-W - venting A

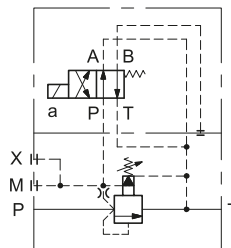

RQM\*-W - venting D

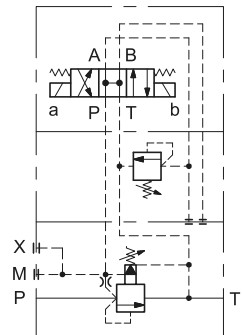



MODEL CODE	MRQA			RQR5-P		RQR7-P	
	MRQA/C	RQR3-P	RQRM3-P	RQA5-P	RQAM5-P	RQA7-P	RQAM7-P
CATALOGUE	21 400	21 410	21 420	21 410	21 420	21 410	21 420
SIZE (ND)	6	10		25		32	
SIZE ISO 6264	03	06		08		10	
TYPE	unloading	unloading	unloading + venting	unloading	unloading + venting	unloading	unloading + venting
p max	350 bar						
Q max	40 l/min	200 l/min		400 l/min		500 l/min	

#### PRESSURE ADJ. RANGE

up to 70 bar	■	■	■	■	■	■	■
up to 210 bar	■	■	■	■	■	■	■
up to 280 bar	■	■	■	■	■	■	■

#### VERSIONS

**R** remote piloting - **A** or **/C** embedded check valve (with subplate - non ISO mounting)

#### FEATURES++

PUMP SWITCH: **1** 75% of set value - **2** 63% of set value (no MRQA)

OPTIONS: **I** internal drainage (RQ\*M-P only) - **M** adjustment knob - **CM** boot (solenoid op. only)

COILS: power supply **DC** 12V, 24V, 48V, 110V, 220V; **AC** 12V, 24V, 48V, 110V, 220V; F110, F220 - DIN 43650 connector



MODEL CODE	Z3-P		Z5-P		ZC2		DZC5	
	MRQA/C	RQR3-P	RQRM3-P	RQA5-P	RQAM5-P	RQA7-P	RQAM7-P	DZC8
CATALOGUE	22 300	22 300	24 300	24 310	24 310	24 310	24 310	24 310
SIZE (ND)			6	10	16	25		
SIZE (ISO)	5781-06	5781-08	5781-03	P05, 4401-05	4401-07	4401-08		
TYPE	reducing 2-way	reducing 2-way	reducing + relieving	reducing + relieving	reducing + relieving	reducing + relieving		
p max	250 bar			350 bar				
Q max	40 l/min	110 l/min	25 l/min	150 l/min	300 l/min	500 l/min		

#### PRESSURE ADJ. RANGE

up to 70 bar			■	■	■	■
up to 140 bar			■	■	■	■
up to 210 bar	■	■	■	■	■	■
up to 280 bar				■	■	■

#### FEATURES++

Z\*-P OPTIONS: **R** reduced drainage - **C** check valve U→E w. cracking pressure 0.5 bar

DZC\* OPTIONS: **I** internal pilot/drain - **E** external pilot/drain - **K** adjustment knob

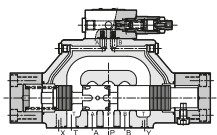

RQR\*-P

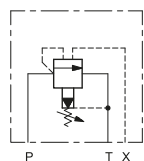

RQAM\*-P

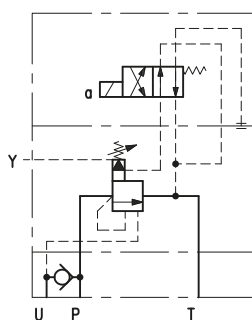

Z\*-P

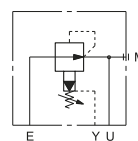

DZC\*

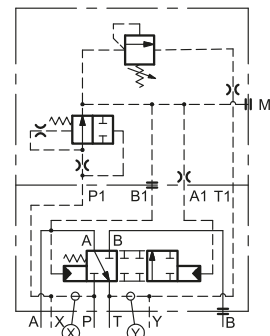

# FLOW VALVES

## IN-LINE

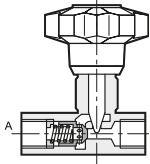
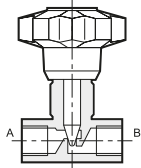

MODEL CODE

**RS\* - throttle**

CATALOGUE	31 200							
SIZE	2	3	4	5	6	7	8	
port THREAD	1/4" BSP	3/8" BSP	1/2" BSP	3/4" BSP	1" BSP	1 1/4" BSP	1 1/2" BSP	
TYPE	throttle							
p max	400				320			
Q nom	15	30	50	80	150	200	220	

MODEL CODE

**RSN\* - throttle check**

CATALOGUE	31 210							
SIZE	2	3	4	5	6	7	8	
port THREAD	1/4" BSP	3/8" BSP	1/2" BSP	3/4" BSP	1" BSP	1 1/4" BSP	1 1/2" BSP	
TYPE	throttle check							
p max	400				320			
Q nom	15	30	50	80	150	200	220	
Q free max	35	80	150	200	300	400	500	

MODEL CODE

**RPC1    RPC1-T3    RPC2    RPC2-T3    RPC3    RPC3-T3**

CATALOGUE	32 200	32 250	32 300	32 350	32 300	32 350
SIZE (ND)	6		10		16	
SIZE ISO 6263	03		06		07	
TYPE	2-way pressure and temperature compensated	3-way pressure and temperature compensated	2-way pressure and temperature compensated	3-way pressure and temperature compensated	2-way pressure and temperature compensated	3-way pressure and temperature compensated
p max	250		320		250	
Δp	10 bar	12 bar	10 bar		12 bar	
Q min contr.	0,025 l/min	0,035 l/min	0,05 l/min	0,06 l/min	0,12 l/min	0,13 l/min

CONTROLLED FLOW

0.5	■					
1; 4; 10; 16	■	■				
22	■	■	■			
30	■					
38			■			
50				■		
70			■			
100					■	
150					■	■

■ FEATURES ++

RPC\*: **C** check valve - **X** check valve + anti-surge pilot signal (RPC1 only) - **M** single turn knob - **RC** compensating stroke governor (RPC2 and RPC3)

RPC\*-T3: **Q** pressure relief valve 10 ÷ 210 bar (RPC2-T3 and RPC3-T3) - **M** single turn knob

■ SYMBOLS

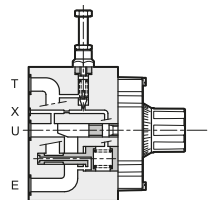
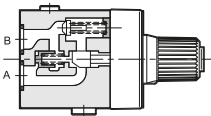
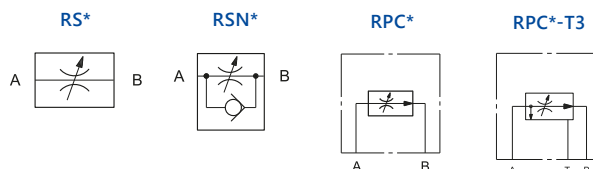



MODEL CODE	PLK08	CR	CRQ	PRK10	DBV	PCK06
CATALOGUE	<b>21 090</b>	<b>21 100</b>	<b>21 110</b>	<b>21 111</b>	<b>21 120</b>	<b>21 140</b>
seat type	SAE 08	D-10E	D-10C	SAE 10	D-10E	D-10D
port THREAD	3/4-16 UNF-2B	ø20,6	ø20,6	7/8-14 UNF-2B	M30 x 1,5	ø20,6
TYPE	direct	direct	pilot	pilot	direct	compensator
p max	400	350	350	350	380	350
Q max	3	50	100	120	120	40

### ■ PRESSURE ADJ. RANGES

PLK08: **035** up to 35 bar - **070** up to 70 bar - **140** up to 140 bar - **210** up to 210 bar - **280** up to 280 bar - **350** up to 350 bar  
 CR: **2** up to 25 bar - **3** up to 70 bar - **4** up to 140 bar - **5** up to 210 bar - **6** up to 350 bar  
 CRQ: **3** up to 70 bar - **4** up to 140 bar - **5** up to 210 bar - **6** up to 350 bar  
 PRK10: **070** 6 ÷ 70 bar - **140** 6 ÷ 140 bar - **210** 6 ÷ 210 bar - **350** 6 ÷ 350 bar  
 DBV: **035** up to 35 bar - **050** up to 50 bar - **080** up to 80 bar - **100** up to 100 bar - **160** up to 160 bar  
**200** up to 200 bar - **250** up to 250 bar - **300** up to 300 bar  
 PCK06: **P** two-way - **PT** three-way - **V** variable adjustment 7 ÷ 33 - **4** fixed adj. 4 bar - **8** fixed adj. 8 bar



MODEL CODE	RS*-I - throttle				
CATALOGUE	<b>31 200</b>				
SIZE (ND)	2	3	4	5	6
port THREAD	M20x1,5	M20x1,5	M27x2	M33x2	M42x2
TYPE	throttle				
p max	320				
Q nom	15	30	50	80	150

MODEL CODE	RSN*-I - throttle check			
CATALOGUE	<b>31 210</b>			
SIZE (ND)	2	3	4	5
port THREAD	M20x1,5	M27x2	M33x2	M42x2
TYPE	throttle check			
p max	320			
Q nom	15	30	50	80
Q free max	35	80	150	200



MODEL CODE	VR2-I	VR5-I	VR7-I	VSK1	VSK2	KT08
CATALOGUE		<b>45 100</b>		<b>45 110</b>	<b>45 110</b>	<b>43 100</b>
port THREAD	1/4"	3/4"	1" 1/4	slip-in ø11,75 mm	M12x1	3/4-16 UNF
TYPE		check valve		shuttle	shuttle	solenoid, poppet
p max	320	250	250	350	350	350
Q max	50	150	300	20	3	50

### ■ FEATURES ++

VR\*-I CRACKING PRESSURE: **1** 0.5 bar - **3** 5 bar - **4** 10 bar  
 KT08: **NO** normally open - **NC** normally closed - ELECTRICAL OPTIONS same as DL3 valve, see at DIRECTIONAL VALVES.

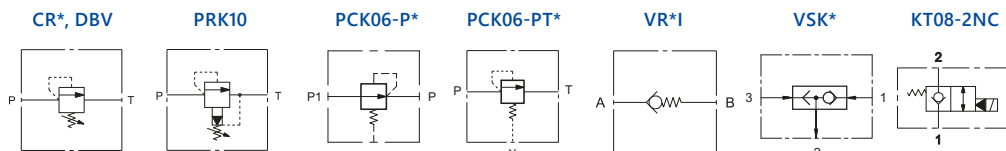

# DIRECTIONAL VALVES

## SOLENOID - DIRECT OPERATED



MODEL CODE	DS2	DS3	DS3L	DS3GL	DL3	DS5	DL5	DL5B
CATALOGUE	41 110	41 150	41 152	41 153	41 211	41 310	41 330	41 335
SIZE	04	06			10			
ISO 4401 / CETOP	02	03			05			
TYPE	Standard	Standard	8W Low consumption	Digital interface	Compact version	Standard	Compact version	Compact version
p max	350 bar	350 bar	280 bar	350 bar	280 bar	320 bar	320 bar	320 bar
Q max	25 l/min	100 l/min	60 l/min	80 l/min	50 l/min	150 l/min	125 l/min	125 l/min
<b>SPOOLS</b>								
S1; S2; S3; S4	■	■	■	■	■	■	■	■
S5; S6; S7; S8		■		■		■		
S9 to S29		■				■		
SA*; SB*	■	■	■	■	■	■	■	■
RSA*; RSB*		■						
TA; TB	■	■	■	■	■	■	■	■
TA/TB 02; TA/TB 23		■		■	■	■	■	■
TA/TB 30; TA/TB 33		■						
RK	■	■	■	■	■	■	■	■
RK1; RK02; 1RK		■		■		■		
<b>COIL TYPE</b>								
D12	■	■		■	■	■	■	■
D14		■						
D24	■	■	■	■	■	■	■	■
D26						■		
D28		■			■			■
D48		■			■			
D110; D125; D220		■			■	■		
A24; A48; A110; A230		■			■	■	■	
F110; F220		■				■		
<b>CONNECTIONS</b>								
K1	■	■	■		■	■	■	■
K2	■	■			■			■
K4					■			
K7	■	■			■	■		■
K7D (diode)		■			■			
K8					■			
K12 (M12 5 pin male)				■				
<b>MANUAL OVERRIDES</b>								
CM	■	■		■	■	■	■	■
CH; CH1		■						
CP		■		■				■
CK; CK1; CK2	■	■		■	■	■		■
CPK		■		■				■

### ■ FEATURES ++

MONITORED: **M** - see dedicated section at page 20

EXPLOSION PROOF: **DSE3K\*** and **DL5BK\*** - see catalogue 41 515

EXTERNAL DRAIN **Y** available for ISO 4401-05 sizes

ALTERNATIVE SURFACE FINISHES: **W7** Zinc-nickel (salt spray resistance up to 600 hours)

DS3 SPECIAL VERSIONS: **F, S** soft-shift - **UL** certified coils - **R** fixing screws as 4WE6\*6X Rexroth

DS3GL FUNCTIONS: **IOL, IOLG** IO-Link interface - **ECG** soft shift (with dedicated spools) - **ECL** power save - **EC1, EC2** low power switch command from PLC.



## S\*

2 solenoids  
3 positions  
spring centering

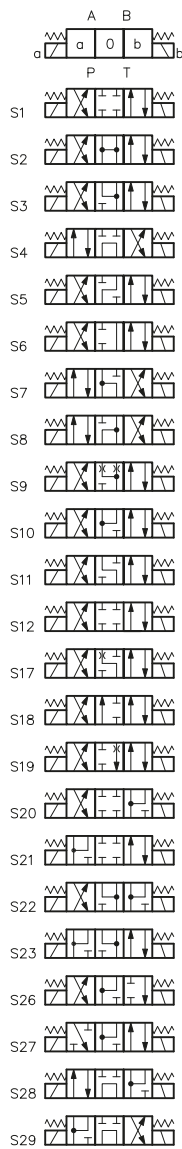

## SA\*

1 solenoid side A  
2 positions  
(central + external)  
with spring return

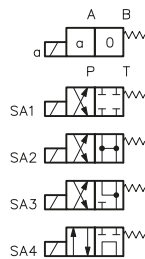

## SB\*

1 solenoid side B  
2 positions  
(central + external)  
with spring return

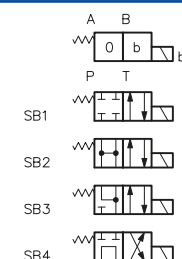

## RSA\*

1 solenoid side A  
2 positions  
(external + central)  
with spring return

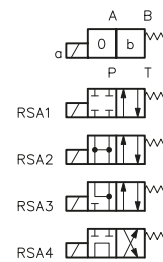

## RSB\*

1 solenoid side B  
2 positions  
(external + central)  
with spring return

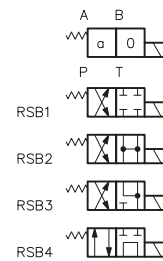

## TA\*

1 solenoid side A  
2 external positions  
with spring return

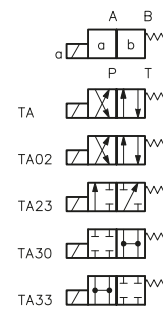

## TB\*

1 solenoid side B  
2 external positions  
with spring return

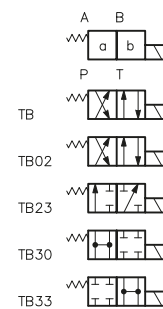

## RK

2 solenoids  
2 positions  
with detent

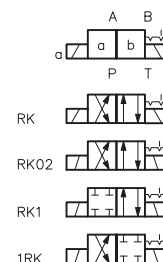

# DIRECTIONAL VALVES SOLENOID - PILOT-OPERATED



MODEL CODE	E4	DSP7	DSP8	DSP10	DSP11
CATALOGUE	41 400	41 420	41 430	41 440	41 440
SIZE (ND)	10	16	25	32	35
CETOP	05, R05	07	08	10	10+
ISO 4401	05	07	08	10	10+
TYPE	solenoid	solenoid	solenoid	solenoid	solenoid
p max	320 bar	350 bar	350 bar	350 bar	350 bar
p max high pressure vers.	420 bar	420 bar	420 bar	-	-
Q max	150 l/min	300 l/min	600 l/min	1100 l/min	1600 l/min

## SPOOLS

S1; S2; S3; S4	■	■	■	■	■
S5; S18	■				
S6 to S12	■	■	■		
S20; S21		■	■		
SA1; SB1	■	■	■	■	■
SA2; SB2 to SA4; SB4		■	■	■	■
TA; TB;	■	■	■	■	■
TA02; TB02	■	■	■	■	■
TA23; TB23	■	■	■		
RK; RK02; RK002	■	■	■	■	■

## COIL TYPE

D12; D24	■	■	■	■	■
D48; D110; D220	■	■	■	■	■
A24; A48; A110; A230	■	■	■	■	■
F110; F220	■	■	■	■	■

## COIL CONNECTIONS

K1	■	■	■	■	■
K7 (D12 and D24 coil)	■	■	■		

## MANUAL OVERRIDE

CM	■	■	■	■	■
----	---	---	---	---	---

## VERSIONS

MONITORED **M** - see dedicated section at page 20

EXPLOSION PROOF **DSP\*K\*** - see catalogue 41 515

HYDRAULIC OPERATED VERSIONS **C** described in the valves datasheets

HIGH PRESSURE VERSION **H**

## FEATURES ++

PILOT / DRAIN: **I** internal - **Z** internal with pressure reducing - **C** internal with built-in backpressure valve - **E** external (always verify application cases in the valve datasheet)

OPTIONS: **C** stroke limiter - **D** shifting speed control - **C - D** stroke + shifting control - **P\***, **PF** restrictor subplate - **S2** Pilot stage with S2 spool (available only with pilot supply E)

ALTERNATIVE SURFACE FINISHING **W7** Zinc-nickel (salt spray resistance up to 600 hours)

## S\*

2 solenoids  
3 positions  
spring centering

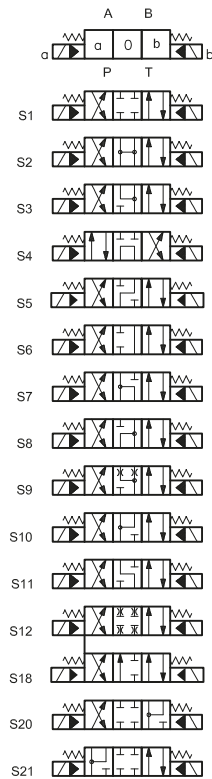

## TA\*

1 solenoid side A  
2 external positions  
with spring return

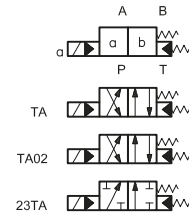

## TB\*

1 solenoid side B  
2 external positions  
with spring return

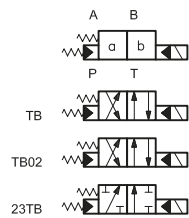

## RK

2 solenoids  
2 positions  
with detent

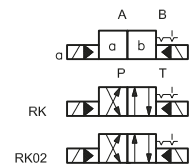

## SA\*

1 solenoid side A  
2 positions  
(central + external)  
with spring return

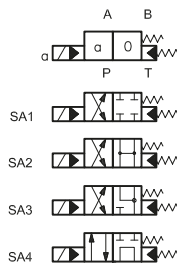

## SB\*

1 solenoid side B  
2 positions  
(central + external)  
with spring return

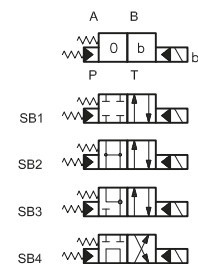



MODEL CODE	DSR3L							
	DSH3	DSH3L	DSR3H	DSA3	DSC3	DSH5	DSA5	DSC5
CATALOGUE	41 600	41 605	41 610	41 620	41 630	41 600	41 620	41 630
SIZE (ND)	06					10		
CETOP	03	03			05			
ISO 4401	03	03			05			
TYPE	lever	lever compact	roller cam	air	hydraulic	lever	air	hydraulic
p max	350 bar	350 bar				320 bar		
Q nom	75 l/min	60 l/min	75 l/min	75 l/min	75 l/min	150 l/min	120 l/min	150 l/min

**SPOOLS**

S1; S2; S3; S4	■	■		■	■	■	■	■
S5 to S23				■			■	
SA1; SA2; SA3; SA4	■			■	■	■	■	■
SB1; SB2; SB3; SB4				■	■		■	■
TA	■	■	■	■	■	■	■	■
TA02, TA23	■			■	■		■	
TB				■	■		■	■
TB02, TB23				■	■		■	
TAK	■	■				■		
TAK02, TAK23	■							
SK1; SK2; SK3; SK4	■	■				■		
SAK1 to SAK4	■					■		
R			■					
RK				■	■		■	■
RK1, RK02; 1RK				■			■	

**FEATURES ++**

DSR3 VERSIONS: **L** compact - **H** heavy duty - **R** two roller (DSR3L only)

ALTERNATIVE SURFACE FINISHING: **W7** Zinc-nickel (salt spray resistance up to 600 hours)



MODEL CODE	ECA	ECB1	ECB2	ECD	ECH
CATALOGUE	49 000				
TYPE	EN 175301-803:2006 form A (ex DIN 43650)				
version	2 poles + GND	2 poles + GND + LED (led ON = energized)		bridge rectifier	RC damping circuit
supply	AC/DC	AC/DC		AC	AC/DC
voltage	up to 230 V	10 to 50 V	70 to 250 V	up to 230 V	up to 230 V
coil type	AC or DC	AC or DC	AC or DC	DC fed w. AC	AC or DC

**FEATURES ++**

ECA COLOR : **B** black - **A** gray



MODEL CODE	ECL	ECF
CATALOGUE	49 300	49 310
TYPE	power saving device	rapid energizing
plug	EN 175301-803 connector	
power supply	8 to 30 V DC	24 to 30 V DC
max current	6A	

For 12 and 24V DC coils

### K1

DIN 43650  
(standard)

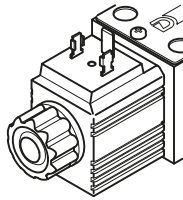

### K2

AMP Junior

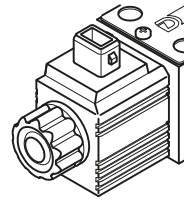

### K4

outgoing cables

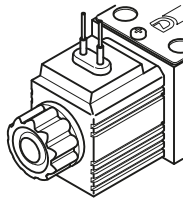

### K7, K7D

for male connector  
DEUTSCH DT06-2S

K7D with internal  
diode to avoid  
voltage peaks

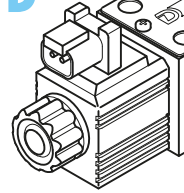

### K8

AMP Super Seal

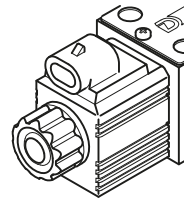

### CM

Boot

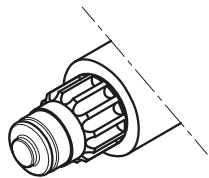

### CK1

Tuning knob,  
DC valves only

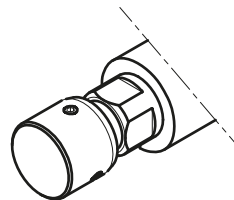

### CP

Push  
DC valves only

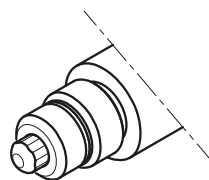

### CK2

Twist and lock knob  
DC valves only

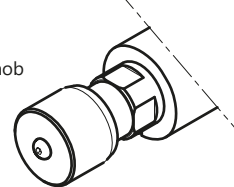

### CPK

Push with detent  
DC valves only

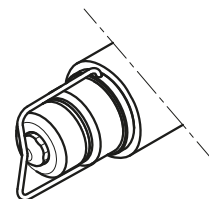

### CH

Lever  
DC valves only

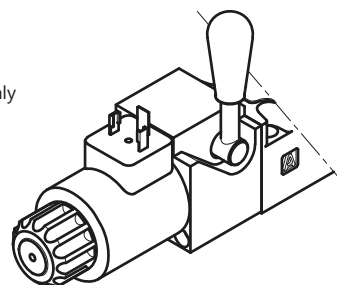

# DIRECTIONAL VALVES SOLENOID - MONITORED

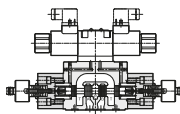

MODEL CODE	DS3M	DS5M	DSP5M DSP5RM	DSP7M	DSP8M	DSP10M
CATALOGUE	41 505					
SIZE	6	10		16	25	32
CETOP	03	05	P05, R05	07	08	10
ISO 4401	03	05	05	07	08	10
TYPE	direct op.	direct op.	pilot op.	pilot op.	pilot op.	pilot op.
p max	350 bar	320 bar		350 bar	350 bar	350 bar
Q max	80 l/min	120 l/min	150 l/min	300 l/min	600 l/min	1100 l/min

## FEATURES ++

The compliance of these valves with the CE safety requirements has been verified by TÜV Sud.  
 COIL TYPE: **D12** 12V DC - **D24** 24V DC - **D110** 110V DC - **D220** 220V DC; **K1** DIN 43650 connection  
 SENSOR SUPPLY VOLTAGE: 24V or **12** 12V (available for monitored positions type M\* only)



## RO

1 sensor  
 central  
 position  
 monitored  
 spools: **S\***

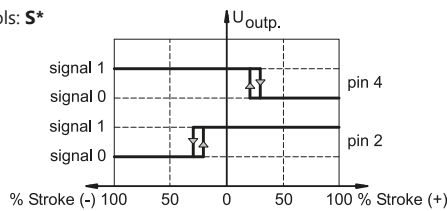
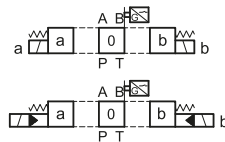

## MO

2 sensors  
 central  
 position  
 monitored  
 spools: **S\***

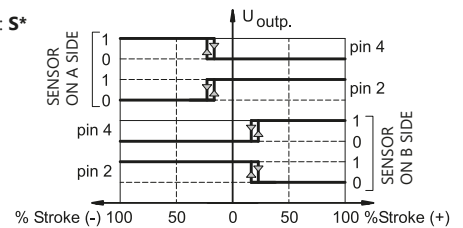
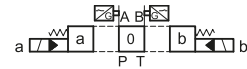

## MAB

2 sensors  
 2 external  
 positions  
 monitored  
 spools:  
**S\***

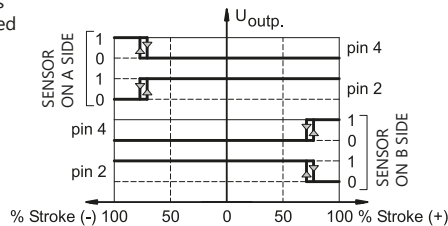
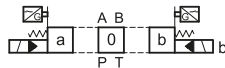

2 positions  
 monitored  
 spools:  
**SA\*, TA\***

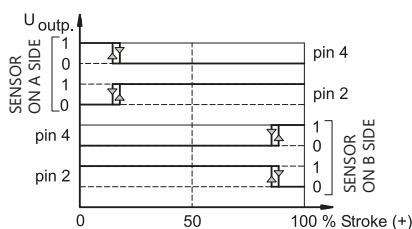
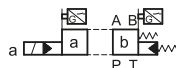

2 positions  
 monitored  
 spools: **SB\*, TB\***

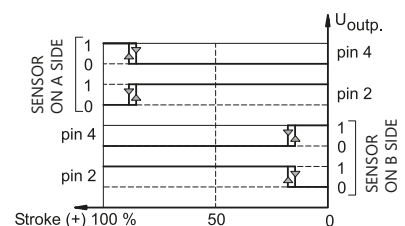
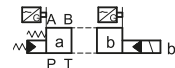

### AVAILABLE SPOOLS/MONITORED POSITIONS

	S*	SA* SB*	TA TA100	TA02	TB TB100	TB02	RK
<b>DS3M</b>							
R0	■						
MA		■	■	■	■		
MB		■	■	■	■		
<b>DS5M</b>							
R0	■						
MA		■	■	■	■	■	
MB		■	■	■	■	■	
<b>DSP*M</b>							
R0	■						
MA		■	■		■		■
MB		■	■		■		■
M0	■						
MAB	■	■	■		■		

### SPECIALS

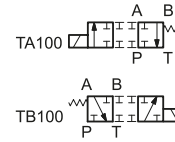

Refer to the 'solenoid operated' section for standard spools, and to the 41505 datasheet for the range of available spools.

## MA

1 sensor  
spools:  
**SA\*, TA\***  
actuated position  
monitored

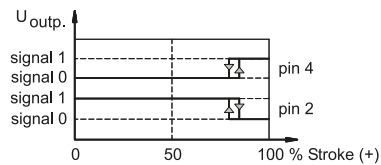
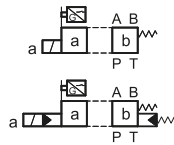

spools:  
**SB\*, TB\***  
initial position  
monitored

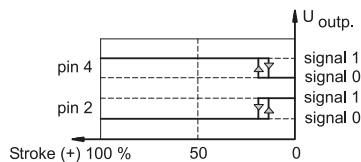
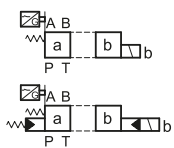

spools: **RK**  
'A' position  
monitored

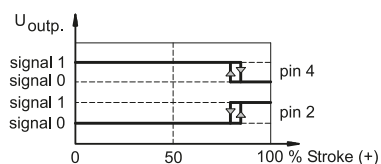
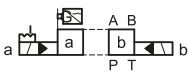

## MB

1 sensor  
spools:  
**SA\*, TA\***  
initial position  
monitored

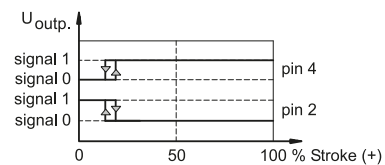
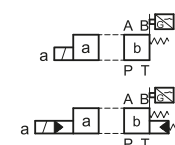

spools:  
**SB\*, TB\***  
actuated position  
monitored

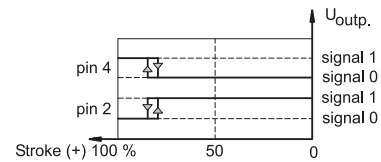
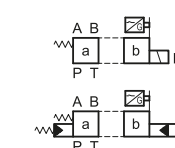

spools: **RK**  
'B' position  
monitored

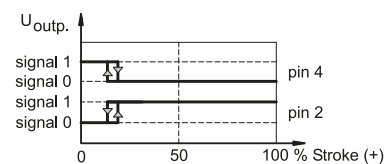
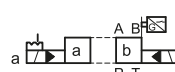

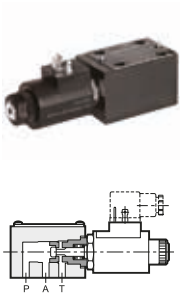

MODEL CODE	<b>DT03-3A</b>	<b>DT03-3B</b>	<b>DT03-3C</b>	<b>DT03-3D</b>	<b>DT03-2E</b>	<b>DT03-2F</b>	<b>DT03-2G</b>	<b>DT03-2H</b>
CATALOGUE	<b>42 200</b>							
Size (ISO)	4401-03							
TYPE	subplate mounting, 3-way solenoid operated				subplate mounting, 2-way solenoid operated			
p max	250 bar							
Q max	12 l/min	25 l/min	25 l/min	25 l/min	25 l/min	12 l/min	25 l/min	25 l/min

**FEATURES ++**

SUPPLY VOLTAGES: direct current **12V-CC** 12 V - **24V-CC** 24 V; alternating current **24RAC** 24 V - **110RAC** 110V - **220RAC** 220 V  
 RESTRICTORS PLUG ON P LINE: **D08** orifice Ø0.8 - **D10** orifice Ø1  
 EXPLOSION PROOF **DT3K\*-3\*\*** - see catalogue 42 215

**SYMBOLS**

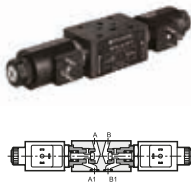
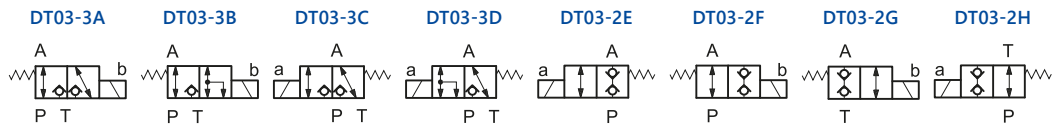

MODEL CODE	<b>MDT-SA</b>	<b>MDT-SB</b>	<b>MDT-D</b>
CATALOGUE	<b>42 250</b>		
Size (ISO)	4401-03		
TYPE	modular version		
p max	250 bar		
Q max	25 l/min	25 l/min	25 l/min

**FEATURES ++**

SUPPLY VOLTAGES: direct current **12V-CC** 12 V - **24V-CC** 24 V; alternating current **110RAC** 110V - **220RAC** 220 V

**SYMBOLS**

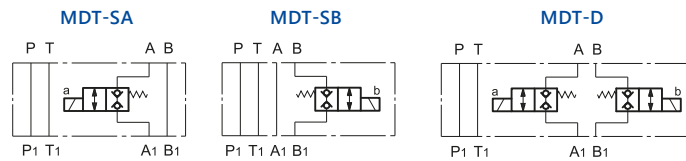





MODEL CODE	VD*-W							
CATALOGUE	45 200							
*	2	3	4	5	6	7	8	9
port THREAD	1/4" BSP	3/8" BSP	1/2" BSP	3/4" BSP	1" BSP	1 1/4" BSP	1 1/2" BSP	2" BSP
TYPE	check							
p max	400 bar				320 bar			
Q nom	25 l/min	40 l/min	75 l/min	125 l/min	200 l/min	280 l/min	650 l/min	850 l/min

**FEATURES ++**

CRACKING PRESSURE: **1** 0,35 bar - **2** 2 bar - **T4** 4 bar - **3** 6 bar - **4** 10 bar



MODEL CODE	VR3-P	VR5-P	VR7-P	VP3-P*-MU	VP5-P*-MU
CATALOGUE	45 300			46 300	
port dimensions	3/8" BSP	3/4" BSP	1" 1/4 BSP	ISO 5781-06	ISO 5781-08
TYPE	check			p.o. check	
p max	350 bar	350 bar	250 bar	320 bar	320 bar
Q max	100 l/min	200 l/min	400 l/min	50 l/min	100 l/min

**VR\*P FEATURES ++**

CRACKING PRESSURE: **1** 0,5 bar - **3** 5 bar - **4** 10 bar

**VP\*-P\*-MU FEATURES ++**

CRACKING PRESSURE: **2** 3,5 bar - **3** 5 bar

OPTION: **P** decompression device



MODEL CODE	CFP-S*						
CATALOGUE	46 400						
*	032	040	050	063	080	100	125
Size (ND)	32	40	50	63	80	100	125
TYPE	filling valves						
p max	350 bar						
Q max	160 l/min	250 l/min	400 l/min	600 l/min	1000 l/min	1600 l/min	2500 l/min

**FEATURES ++**

OPTION: **0** without pre-opening - **P** with pre-opening (not available for ND 125)

**SYMBOLS**

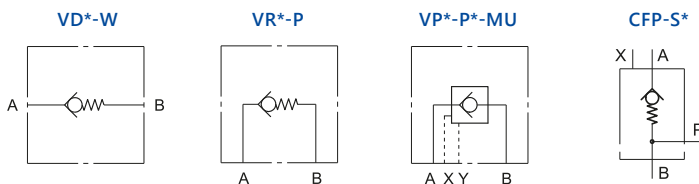

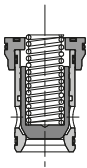

MODEL CODE	LC*					
CATALOGUE	48 900					
SIZE (ND)	16	25	32	40	50	63
TYPE	ISO 7368 slip-in cartridge valves					
p max	420					
Q max QS	250 l/min	500 l/min	900 l/min	1300 l/min	2000 l/min	3000 l/min
Q max QD	200 l/min	450 l/min	800 l/min	1100 l/min	1700 l/min	2700 l/min
Q max PS	200 l/min	400 l/min	900 l/min	1000 l/min	1500 l/min	2500 l/min

### TYPE

QS0.5	■	■	■	■	■	
QS2	■	■	■	■	■	■
QD4	■	■	■	■	■	
PS1						■
PS2	■	■	■	■	■	

### VERSIONS

QS flow control (1:1,66) - QD flow control with damping nose (1:1,66) - PS pressure control (1:1)

### FEATURES ++

CRACKING PRESSURE: 0.5 0,5 bar - 1 1 bar - 2 2 bar - 4 4 bar

OPTIONS: LL low leakage (not available for QS 0.5 and LC16-PS\*)

### SYMBOLS

LC\*QS

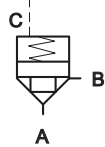

LC\*QD

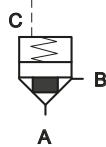

LC\*PS

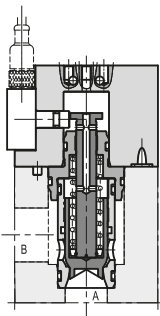
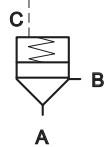

MODEL CODE	LCM*				
CATALOGUE	48 900				
SIZE (ND)	16	25	32	40	50
TYPE	ISO 7368 slip-in cartridge valves				
p max	350				
Q max QS	250 l/min	500 l/min	900 l/min	1300 l/min	2000 l/min

### FEATURES ++

The compliance of these valves with the CE safety requirements has been verified by TÜV Sud.

CRACKING PRESSURE: 4 bar

MONITORING: PNP type NO, closed position monitored, 24V DC

COVER FUNCTION: D check valve - Z piloting of other cartridges - Q flow control (for ND 16, 25 and 50 only)

OPTIONS: LL low leakage



### SYMBOLS

LCM\*D

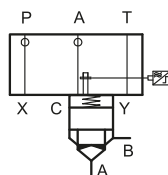

LCM\*Z

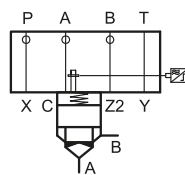

LCM\*Q

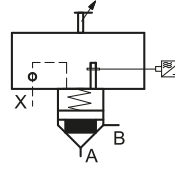

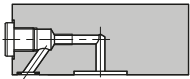

MODEL CODE	LP*					
CATALOGUE	48 900					
SIZE (ND)	16	25	32	40	50	63
TYPE	covers					
<b>TYPE</b>						
R	■	■	■			■
D	■	■	■	■	■	■
DZ	■	■	■	■		
DF1	■	■	■	■	■	
DF2	■	■	■	■	■	
Q	■	■	■	■	■	■
DP4	■	■	■	■	■	■
DP6	■	■	■	■	■	■
DPE4	■	■	■	■	■	
DPE6	■	■	■	■	■	

### FUNCTIONS

- R** directional control and check valve with external pilot x - **D** directional control and check valve
- DZ** directional control with possibility to pilot other cartridges in line - **DF1** directional control and check with double pilot line - **DF2** directional control and check with priority piloting from two external lines
- Q** flow control - **DP4** pressure control with a built-in relief valve set 140 bar - **DP6** pressure control with a built-in relief valve set 350 bar - **DPE4** pressure control by means of proportional valve set 140 bar - **DPE6** pressure control by means of proportional valve set 350 bar

### SYMBOLS

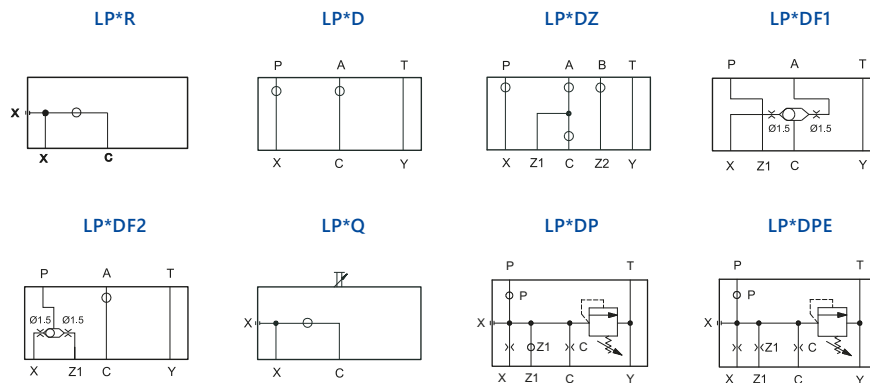

### ■ STACK VALVES OVERVIEW

All modular valves with screw adjustment may be provided with **ADJUSTMENT KNOB**, with the exception of the valves of size ISO 4401-02. Some valves may be provided with zinc-nickel surface finishing. Contact our Sales Dept. for more detailed information.

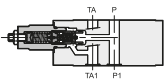

MODEL CODE	PRM2	PRM3	MRQ	PRM5	PRM7	PBM3
CATALOGUE	<b>61 100</b>	<b>61 201</b>	<b>61 220</b>	<b>61 310</b>	<b>61 411</b>	<b>61 260</b>
SIZE	4	6	6	10	16	6
ISO 4401 / CETOP	02	03	03	05	07	03
TYPE	relief, direct operated		relief, pilot operated			backpressure
p max	320 bar	350 bar	350 bar	350 bar	350 bar	350 bar
Q max	20 l/min	50 l/min	75 l/min	120 l/min	300 l/min	50 l/min
Q max free lines		75 l/min				75 l/min

#### VERSIONS

PT; SP (P → T)	■	■	■	■	■	
AT; SAT (A → T)		■	■	■		
BT; SBT (B → T)	■	■	■	■		
DT (A and B → T)	■	■	■	■		
BA; SB (B → A)		■	■			
D, cross (A→B and B → A)		■	■	■		
B→B1						■

#### ■ PRESSURE ADJ. RANGES

PRM2: **4** 63 ÷ 125 bar - **5** 80 ÷ 210 bar - **6** 125 ÷ 320 bar

PRM3: **025** up to 25 bar - **070** up to 70 bar - **140** up to 140 bar - **210** up to 210 bar - **350** up to 350 bar

MRQ: **2** up to 25 bar - **3** up to 70 bar - **4** up to 140 bar - **5** up to 210 bar - **6** up to 350 bar

PRM5: **070** 14 ÷ 70 bar - **140** 14 ÷ 140 bar - **210** 14 ÷ 210 bar - **350** 14 ÷ 350 bar

PRM7: **035** 6 ÷ 35 bar - **070** 6 ÷ 70 bar - **150** 8 ÷ 150 bar - **250** 10 ÷ 250 bar - **350** 10 ÷ 350 bar

PBM3: **2** up to 25 bar - **3** up to 70 bar - **4** up to 140 bar

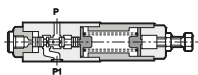

MODEL CODE	PZM2	PZM3	PZM5	PZM7	MSD	SD4M
CATALOGUE	<b>62 100</b>	<b>62 201</b>	<b>62 310</b>	<b>62 411</b>	<b>63 200</b>	<b>63 300</b>
SIZE	4	6	10	16	6	10
ISO 4401 / CETOP	02	03	05	07	03	05, R05
TYPE	reducer				sequence	
p max	320 bar	350 bar	350 bar	350 bar	350 bar	320 bar
Q max	20 l/min	50 l/min	80 l/min	300 l/min	50 l/min	80 l/min
Q max free lines	30 l/min	75 l/min	100 l/min		75 l/min	100 l/min

#### VERSIONS

I; P (reduction in P)	■	■	■	■	■	■
A; PA (reduction in A)		■	■	■		
B; PB (reduction in B)	■	■	■			

#### ■ PRESSURE ADJ. RANGES

PZM2: **2** 10 ÷ 25 bar - **3** 20 ÷ 63 bar - **4** 10 ÷ 160 bar - **5** 50 ÷ 210 bar

PZM3: **035** 3 ÷ 35 bar - **070** 10 ÷ 70 bar - **140** 30 ÷ 140 bar - **280** 50 ÷ 280 bar

PZM5: **070** 8 ÷ 70 bar - **150** 8 ÷ 150 bar - **280** 10 ÷ 280 bar

PZM7: **035** 6 ÷ 35 bar - **070** 6 ÷ 70 bar - **150** 8 ÷ 150 bar - **250** 10 ÷ 250 bar - **300** 10 ÷ 300 bar

MSD: **3** 10 ÷ 70 bar - **4** 30 ÷ 140 bar - **5** 50 ÷ 280 bar

SD4M: **3** up to 70 bar - **4** up to 140 bar - **5** up to 210 bar

#### ■ SYMBOLS

PRM2-PT, MCD-SP

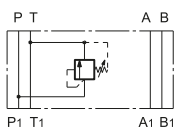

MRQ-SP

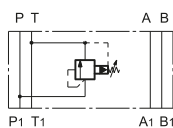

PRM7-PT

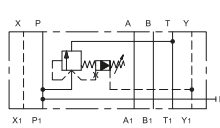

PBM3

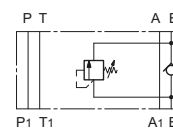

PZM3

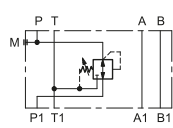

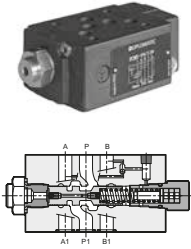

MODEL CODE	PCM3-P	PCM3-PT	PCM5-P	PCM5-PT	PCM7-P	PCM8-P
CATALOGUE	63 310		63 320		63 330	63 520
SIZE	6		10		16	25
ISO 4401 / CETOP	03		05		07	08
TYPE	2-way compensator	3-way compensator	2-way compensator	3-way compensator	2-way compensator	2-way compensator
p max	350 bar		350 bar		350 bar	350 bar
Q max	40 l/min		100 l/min	110 l/min	280 l/min	300 l/min

### ■ PRESSURE ADJ. RANGES

PCM3: **V** variable 7 to 33 bar - **4** 4 bar - **8** 8 bar

PCM5, PCM7 : **4** 4 bar - **8** 8 bar

PCM8: **8** 8 bar



MODEL CODE	QTM2	QTM3	QTM5	QTM7
CATALOGUE	64 100	64 201	64 310	64 411
SIZE	4	6	10	16
ISO 4401 / CETOP	02	03	05	07
TYPE	flow restrictor			
p max	320 bar	350 bar	350 bar	350 bar
p cracking	0,4 bar	0,5 bar	0,5 bar	0,7 bar
Q max	30 l/min	50 l/min	120 l/min	300 l/min

### METER OUT

SA (on line A)	■	■	■	■
SB (on line B)	■	■	■	
D (on line A and B)	■	■	■	■

### METER IN

RSA (on line A)		■ (G)	■	
RSB (on line B)		■ (G)	■	
RD (on line A and B)		■	■	

### ■ QTM3 FEATURES ++

**G\*** VERSION: the valve body does not provide the OR seats.

The mounting interface is achieved by interposition of an OR subplate, included. The flow control (meter-in or meter-out) depends on the way of assembly the valve on the subplate.

The G version is available with SA, SB and D configurations.

Z4M\*-A, PZM7-PA

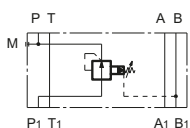

MSD

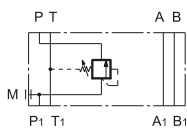

SD4M

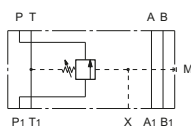

PCM\*-PV

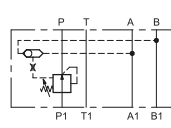

PCM\*-PT

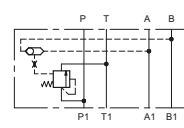

QTM3-D, QTM\*-D

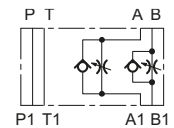

# STACK VALVES

## CHECK VALVES

## FLOW CONTROL

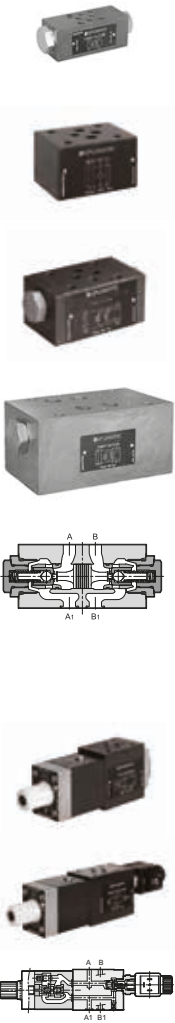

MODEL CODE	CHM2	MVR	MVR-RS/P	CHM3	CVM5	CHM5	CHM7
CATALOGUE	65 100	65 200	65 210	65 251	65 301	65 360	65 410
SIZE	4	6		10		16	
ISO 4401 / CETOP	02	03		05		07	
TYPE	pilot operated	check valve	w. restrictor	pilot operated	check valve,	pilot operated	pilot operated
p max	320 bar	350 bar		350 bar		350 bar	350 bar
p cracking	2 bar	0,5; 3; 5 bar	1 bar	3 bar	0,5; 8 bar	2 bar	2 bar
Q max	30 l/min	50 l/min		100 l/min		120 l/min	300 l/min
Q max free lines		75 l/min					

### CHECK VALVE

SP, P (on line P)		■	■		■		
SA (on line A)	■	■		■	■	■	■
SB (on line B)	■	■		■	■	■	■
ST (on line T)		■			■		
D (on line A and B)	■	■		■		■	■
PT, SPT (on line P and T)		■					

MODEL CODE	RPC1*M	RPC1*4M	RLM3
CATALOGUE	66 200	66 300	66 260
SIZE	6	10	6
ISO 4401 / CETOP	03	05	03
TYPE	adjustment compensated in flow and temperature		solenoid speed control
p max	250 bar	250 bar	250 bar
Q max free lines	65 l/min	120 l/min	65 l/min
Q reverse free	40 l/min	40 l/min	-

### METER-OUT

A (on line A)	■	■	■
B (on line B)	■	■	
D (on line A and B)	■	■	
T (on line T)	■		■

### METER-IN

P (on line P)	■		
PCT3 (on line P w. adj on T)	■		

### FEATURES ++

FLOW ADJUSTMENT RANGE: **K** body only (without flow control valve). **1** 1 l/min - **4** 4l/min - **10** 10 l/min - **16** 16 l/min  
**22** 22 l/min - **30** 30 l/min

RLM3 ONLY: for **A** normally open - **C** normally closed solenoid valve.

ELECTRICAL OPTIONS same as DL3 valve, see at DIRECTIONAL VALVES.

### SYMBOLS

CHM\*-D

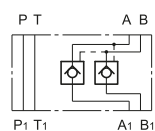

MVR-D

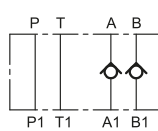

MVR-RS/P

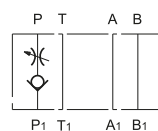

CHM3-D

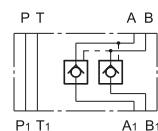

CVM5-SP

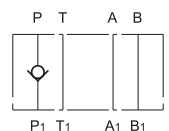

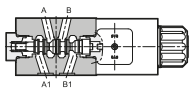

MODEL CODE	MDS3	MDS5	KTM3	M*F3(M)	MDT
CATALOGUE	41 251	41 351	43 100	41 270	42 250
SIZE	6	10	6		
ISO 4401 / CETOP	03	05	03		
TYPE	directional		NC and NO, poppet	shut-off	poppet directional
p max	350 bar		350 bar	350 bar	250 bar
Q max	50 l/min	100 l/min	40 l/min	50 l/min	25 l/min

### ■ MDS3 ++

AVAILABLE SPOOLS: **S1, S12, SA1, SA12, SB1, SB12, S3, RSA1, RSB1, TA, TB, TA31, TB31**. See spools schemes at DIRECTIONAL VALVES.

POWER SUPPLY: **DC** 12V, 24V, 28V, 48V, 110V, 220V; **AC** 24V, 48V, 110V, 220V

COIL CONNECTION: **K1** DIN 43650 - **K7** Deutsch (D12 and D24 only)

MANUAL OVERRIDES: **CM** boot - **CP** push - **CPK** push w. detent

### ■ MDS5 ++

AVAILABLE SPOOLS: **S1, SA1, SB1, TA, TB**. See spools schemes at DIRECTIONAL VALVES.

POWER SUPPLY: **DC** 12V, 24V; **AC** 24V, 48V, 110V, 230V

COIL CONNECTION: **K1** DIN 43650

MANUAL OVERRIDES: **CM** boot

### ■ KTM3 ++

**NO** normally open - **NC** normally closed

VERSIONS: **P** shut-off of the outlet pressure - **PT** shut-off between P and T lines

**D** shut-off of A and B lines, outgoing - **RD** shut-off of A and B lines, incoming

**SB** shut-off of B line, outgoing

OPTIONS: **CM** boot

ELECTRICAL OPTIONS same as DL3 valve, see at DIRECTIONAL VALVES.

### ■ MD\*F3 ++

VERSIONS: **D** solenoid actuation - **C** hydraulic actuation

CONTROL ELEMENT SIDE: **A** or **B**

SPOOL: **F1** closed - **F3** float - **FP** parallel - **FC** cross

POWER SUPPLY: **DC** 12V, 24V, 48V, 110V, 220V - DIN 43650 connections.

### ■ MD\*F3M ++

VERSIONS: **D** solenoid actuation - **C** hydraulic actuation

CONTROL ELEMENT SIDE: **A** or **B**

SPOOL: **F1** closed - **FP** parallel - **FC** cross

POWER SUPPLY: **DC** 12V, 24V, 48V, 110V, 220V - DIN 43650 connections.

MONITORED POSITION **MA** or **MB**

### ■ MDT ++

**A** initial position open - **C** initial position closed

VERSIONS: **SA** control on line A - **SB** control on line B - **D** control on lines A and B

SUPPLY VOLTAGES: direct current **12V-CC** 12 V - **24V-CC** 24 V;

alternating current **110RAC** 110V - **220RAC** 220 V - DIN 43650 connections.

### ■ MDS3 SPECIALS

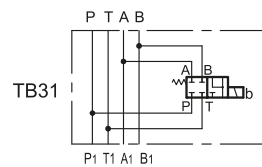
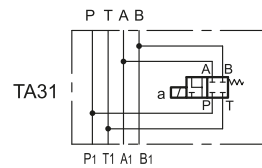

Please refer to the 'solenoid operated' section for standard spools.

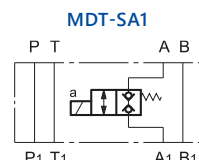
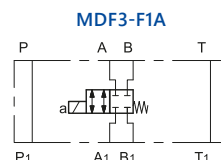
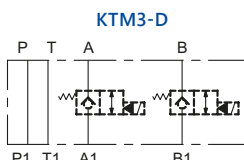
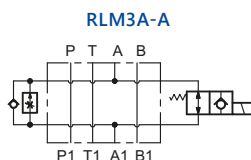
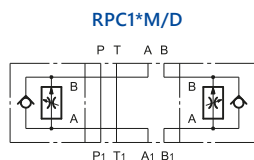



**E** **PROPORTIONAL CONTROL**  
 COIL CONNECTION: **K1** DIN 43650 style - **K7** Deutsch  
 POWER SUPPLY: **D12** 12V DC - **D24** 24V DC

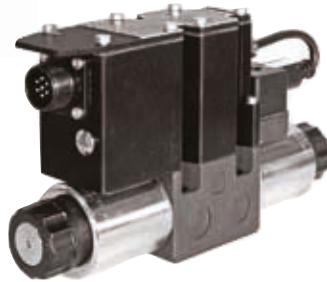

**G** **WITH ON-BOARD ELECTRONICS**  
 Standard - **L** Compact - **H** Fieldbus

**J** **WITH ON-BOARD ELECTRONICS AND FEEDBACK**  
 Standard - **L** Compact - **H** Fieldbus

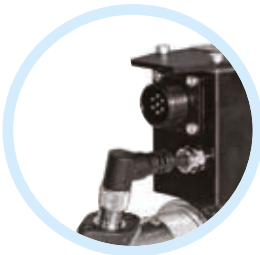
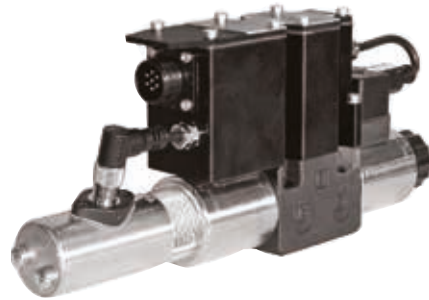

**STANDARD ELECTRONICS**  
 CONNECTION **K11** 6 pin+PE

**E0** analogue, voltage 0...10V or  $\pm 10V$   
**E1** analogue, current 4...20 mA

OPTIONS: **A** external enable  
**B** internal enable - **C** 0V monitor

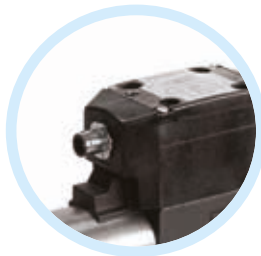

**L** **COMPACT ELECTRONICS**  
 CONNECTION **K12** 5 pin M12

**E0** analogue, voltage 0...10V or  $\pm 10V$   
**E1** analogue, current 4...20 mA  
**IO1** IO-Link  
**CA** CAN Open

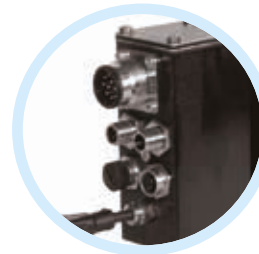

**H** **ELECTRONICS FOR FIELDBUS**  
 MAIN CONNECTION **K16** 11 pin+PE  
**EC** EtherCAT - **EN** Ethernet /IP - **PN** Profinet - **PL** PowerLink

**E0** analogue, voltage 0...10V or  $\pm 10V$   
**E1** analogue, current 4...20 mA  
**FD** full digital version

PORT FOR DIGITAL SENSOR: **1** SSI **2** Encoder  
 PORT FOR ANALOGUE SENSOR: **1** single or double

■ **CONNECTORS AND CABLES** see catalogue 89 000





MODEL CODE	PLKE08	PDE3	PDE3G*	PDE3J*	PRE3	PRE3G*
CATALOGUE	81 101	81 211	81 221	81 231	81 241	81 251
SIZE (ND)	cartridge	06				
SIZE ISO / SAE	SAE-08	4401-03				
TYPE	relief, direct op.	relief direct operated	relief direct operated with OBE	relief with OBE and pressure feedback	relief pilot operated	relief pilot operated with OBE
p max	400 bar	350 bar			350 bar	
Q max	2 l/min	2 l/min			40 l/min	

#### PERFORMANCES

hysteresis	< 5%	< 5%	< 3%	< 1%	< 5%	< 3%
resp. time 0 → 100%	80 ms	60 ms	60 ms	60 ms	80 ms	80 ms
resp. time 100 → 0%	50 ms	70 ms	20 ms	20 ms	40 ms	40 ms

#### PRESSURE ADJ. RANGE

up to 25 bar		■	■		■	
up to 70 bar		■	■		■	■
up to 80 bar	■					
up to 140 bar		■	■	■	■	■
up to 170 bar	■					
up to 210 bar		■	■	■	■	■
up to 250 bar	■					
up to 350 bar	■	■	■	■	■	■

MODEL CODE	PRE10	PRE10G*	PRE10J*	PRE25	PRE25G*	PRE25J*	PRE32	PRE32G*	PRE32J*
CATALOGUE	81 311	81 321	81 331	81 311	81 321	81 331	81 311	81 321	81 331
SIZE (ND)	10			25			32		
SIZE ISO	6264-06			6264-08			6264-10		
TYPE	relief	relief with OBE	relief with OBE and press. feedback	relief	relief with OBE	relief with OBE and press. feedback	relief	relief with OBE	relief with OBE and press. feedback
p max	350 bar								
Q max	200 l/min			400 l/min			500 l/min		

#### PERFORMANCES

hysteresis	< 5%	< 3%	< 1%	< 5%	< 3%	< 1%	< 5%	< 3%	< 1%
resp. time 0 → 100%	70 ms			70 ms			70 ms		
resp. time 100 → 0%	40 ms			40 ms			40 ms		

■ **P\*E\*K\*** ex-proof versions of PDE3, PRE3 and PRE\* available, cat. 81 316

PRESSURE ADJ. RANGE: **025** up to 25 bar (not available for valves with feedback) - **070** up to 70 bar (not available for valves with feedback) - **140** up to 140 bar - **210** up to 210 bar - **350** up to 350 bar

#### SYMBOLS

PLKE08

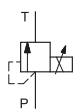

PDE3G\* / J\*

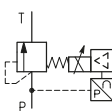

PRE3

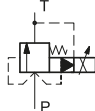

PRE3G\*

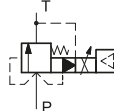

PRE\*

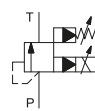

PRE\*G\* / J\*

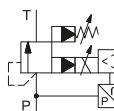

# PROPORTIONAL VALVES

## PRESSURE CONTROL



MODEL CODE	PZME3	PZME5	PZE3	PZE3G*	PZE3J*	ZDE3	ZDE3G*
CATALOGUE	81 506	81 540	81 501	81 502	81 503	81 510	81 520
SIZE (ND)	06	10	06			06	
SIZE ISO	4401-03	4401-05	4401-03			4401-03	
TYPE	pr. reducing		three-port pr. reducing, pilot operated			reducing, direct acting	
	stackable, pilot operated			with OBE	with OBE and pressure feedback		with OBE
p max	320 bar	320 bar	350 bar			100 bar	
Q max	40 l/min	100 l/min	50 l/min			15 l/min	

### PERFORMANCES

hysteresis	<3%	<3%	< 5%	< 3 %	< 1 %	< 4%	< 3%
resp. time 0 → 100%	60 ms	40 ms	90 ms	90 ms	90 ms	30 ms	20 ms
resp. time 100 → 0%	60 ms	50 ms	90 ms	90 ms	40 ms	30 ms	20 ms

### ■ PZME3

PRESSURE ADJ. RANGE: **070** 5 ÷ 70 bar - **150** 0 ÷ 150 bar - **230** 0 ÷ 230 bar

### ■ PZME5

PRESSURE ADJ. RANGE: **070** 7 ÷ 80 bar - **150** 7 ÷ 165 bar - **230** 17 ÷ 230 bar

### ■ PZE3, PZE3G, PZE3J

PRESSURE ADJ. RANGE: **025** 0 ÷ 25 bar - **070** 0 ÷ 70 bar - **140** 0 ÷ 140 bar - **210** 0 ÷ 210 bar - **310** 0 ÷ 310 bar

### ■ ZDE3, ZDE3G

**D** pressure reduction in A and B - **SA** pressure reduction in A (solenoid on side B) no ZDE3G - **SB** pressure reduction in B (solenoid on side A)

OPTIONS: **CM** boot manual override - **CS** screw manual override

VERSIONS: **ZDE3K\*** ex-proof version available, cat. 81 515



MODEL CODE	DZCE5	DZCE5G*	DZCE7	DZCE7G*	DZCE8	DZCE8G*
CATALOGUE	81 601	81 611	81 601	81 611	81 601	81 611
SIZE (ND)	10		16		20	
SIZE ISO	4401-05, R05, P05		4401-07		4401-08	
TYPE	three-port pressure reducing / relieving valve					
p max	350 bar					
Q max	150 l/min		300 l/min		500 l/min	

### PERFORMANCES

hysteresis	< 4%	< 2%	< 4%	< 2%	< 4%	< 2%
resp. time 0 → 100%	100 ms	100 ms	100 ms	100 ms	100 ms	100 ms
resp. time 100 → 0%	50 ms	50 ms	50 ms	50 ms	50 ms	50 ms

■ **DZCE\*K\*** ex-proof versions available, cat. 81 605

PRESSURE ADJ. RANGE: **070** 1 ÷ 70 bar - **140** 1 ÷ 140 bar - **210** 1 ÷ 210 bar - **300** 1 ÷ 300 bar

OPTIONS: **I** internal pilot /drain - **E** external pilot /drain

### ■ SYMBOLS

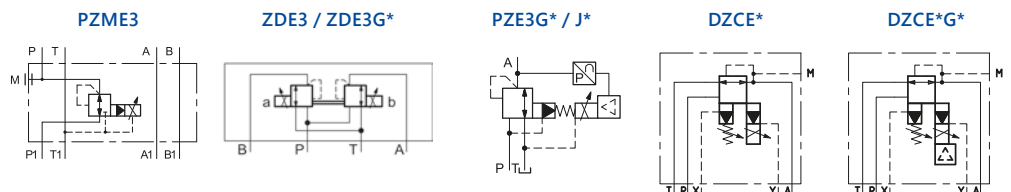



MODEL CODE	RPCED1	RPCER1	RPCED1-T3	QDE3	QDE5
CATALOGUE	82 200	82 250	82 210	82 220	82 220
SIZE (ND)	6			6	10
SIZE ISO / CETOP	6263-03			6263-03	4401-05
TYPE	2-port compensated	2-port compensated + LVDT	3-port compensated	2 or 3-port compensated	2 or 3-port compensated
p max	250 bar				
Δp	10 bar		8 bar	4 and 8 bar	8
Q min controlled	0,025 l/min		0,5 l/min	0,4 l/min	2 l/min

#### PERFORMANCES

hysteresis	< 6 %	< 2,5 %	< 6 %	< 6 %	< 6 %
response time 0 → 100 %	60 ms	180 ms	60 ms	70 ms	
response time 100 → 0 %	80 ms	150 ms	80 ms	-	-

#### CONTROLLED FLOW

1,5 ; 4 ; 8 ; 16 ; 25	■	■	■		
14 ; 20 ; 30 ; 40				■	
80					■

#### FEATURES ++

COILS: power supply **D12** 12V DC (QDE\* only) - **D24** 24V DC

OPTIONS: **CM** boot manual override (QDE3 only)- **CK / CK1** knob (QDE3 only)- **W7** Zinc-nickel (not for RPCER1)

EXPLOSION PROOF **QDE3K\*** see catalogue 82 225

QDE\* valves are suitable both as restrictive or as bypass flow control, depending on the paths in the mounting surface.



MODEL CODE	RPCE2	RPCE2-T3	RPCE3	RPCE3-T3
CATALOGUE	82 300		82 450	
SIZE ISO / CETOP	6263-06		6263-07	
TYPE	2-port compensated	3-port compensated	2-port compensated	3-port compensated
p max	250 bar		250 bar	
Δp	10 bar		10 bar	
Q min contr.	0,2 l/min	0,5 l/min	0,5 l/min	1,5 l/min

#### PERFORMANCES

hysteresis	< 8 %			
response time 0 → 100 %	250 ms		250 ms	
response time 100 → 0 %	120 ms		120 ms	

#### CONTROLLED FLOW

35	■ G			
37	■			
72	■			
80		■		
100			■ (G)	■

#### FEATURES ++

**E** external pilot - **G** differential gain. Available only in RPCE2 at 35 l/min and in RPCE3 at 100 l/min

#### SYMBOLS

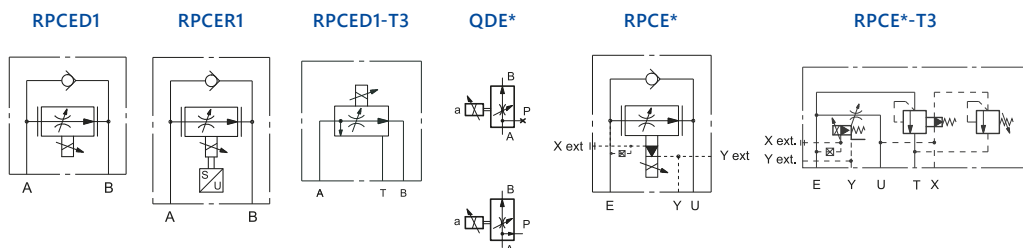

# PROPORTIONAL VALVES

## DIRECTIONAL CONTROL



MODEL CODE	DSE2	DSE3	DSE3B	DSE3F	DSE3G*	DSE3J*	DSE5	DSE5G*	DSE5J
CATALOGUE	83 100	83 210	83 215	83 240	83 220	83 230	83 260	83 270	83 280
SIZE (ND)	03	06				10			
CETOP	02	03				05			
ISO 4401	02	03				05			
TYPE	proportional valve, direct acting								
	standard	standard	basic	with LVDT	with OBE	with LVDT + OBE	standard	with OBE	with LVDT + OBE
p max	350 bar	350 bar				320 bar			
Q max	20 l/min	40 l/min				80 l/min	95 l/min		180 l/min

### PERFORMANCES

hysteresis	< 6 %	< 6 %	< 6 %	< 1,5 %	< 3 %	< 0,2 %	< 6 %	< 3 %	< 0,2 %
response time 0 → 100 %	60 ms	50 ms	50 ms	30 ms	55 ms	20 ms	50 ms	55 ms	40 ms
response time 100 → 0 %	60 ms	40 ms	40 ms	25 ms	30 ms	20 ms	40 ms	60 ms	30 ms
frequency resp. (± 10%) magnitude at -3dB	-	-	-	-	-	40 Hz	-	-	35 Hz
phase lag at 90°	-	-	-	-	-	50 Hz	-	-	35 Hz

### NOMINAL FLOW (10 bar Δp)

1	■	■				■	■		
4	■	■				■	■		
8	■	■	■	■	■				
12						■			
16		■	■	■	■				
16/08		■			■				
18						■			
26		■	■	■	■				
26/13		■			■				
30						■	■	■	
30/15						■			
50									■
60							■	■	
60/30							■	■	
75									■
70/35									■

### MANUAL OVERRIDES

CM	■	■	■			■		■	
CS	■	■	■			■			
CH		■							
CK / CK1	■	■	■			■	■	■	
CK2								■	

Manual overrides availability may be limited to certain versions of the valves. Please consult the related catalogue for details.

### FEATURES ++

EXPLOSION PROOF **DSE3K\*** see datasheet 83 510

FAIL SAFE POSITION **FS** available for valves type 'J' with spools type Z

DSE5 EXTERNAL DRAIN **Y** mounting surface ISO 4401-05-05-0-05 - **L** mounting surface ISO 4401-05-06-0-05

ALTERNATIVE SURFACE FINISHING: **W7** Zinc-nickel (salt spray resistance up to 600 hours)

## CZ\*

OVERRIDDEN  
OVERLAP

for DSE\*G only

CZ\* a b

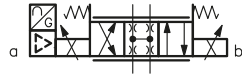

## Z\*

ZERO OVERLAP

for DSE\*J only

Z\* a b



Z\*FS a b

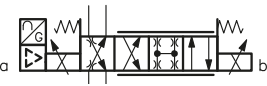

## C\*

CLOSED CENTRE

\*SB version may be  
not available on  
certain type of valves

C\* a b

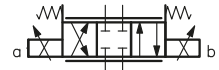

C\*SA a b



C\*SB

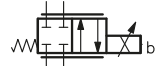

## A\*

OPEN CENTRE

\*SB version may be  
not available on  
certain type of valves

A\* a b

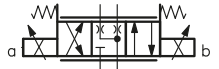

A\*SA a b

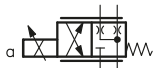

A\*SB

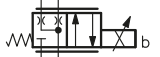

# PROPORTIONAL VALVES

## DIRECTIONAL CONTROL



MODEL CODE	DSPE5 to DSPE11					DSPE5G* to DSPE11G*				
CATALOGUE	83 310					83 320				
SIZE (ND)	10	16	25	32	35	10	16	25	32	35
CETOP	P05, R05	07	08	10	10+	P05, R05	07	08	10	10+
ISO 4401	05	07	08	10	10+	05	07	08	10	10+
TYPE	proportional directional valves, pilot operated									
	standard					with OBE				
p max	350 bar					350 bar				
Q max (l/min)	180	450	800	1800	2000	180	450	800	1800	2000

### PERFORMANCES

hysteresis	< 4 %					< 2 %				
response time 0 → 100%	50 ms	80 ms	100 ms	200 ms	200 ms	35 ms	55 ms	75 ms	140 ms	140 ms
response time 100 → 0%	40 ms	50 ms	70 ms	120 ms	120 ms	25 ms	35 ms	50 ms	160 ms	160 ms

### NOMINAL FLOW AT 10 bar Δp

80, 80/40	■					■				
100		■					■			
150, 150/75		■					■			
200			■					■		
300, 300/150			■					■		
350				■					■	
500, 500/250				■					■	
800				■					■	
800/500									■	
1000					■					■

MODEL CODE	DSPE5J*	DSPE7J*	DSPE8J*	DSPE10J*	DSPE11J*
CATALOGUE	83 330				
SIZE (ND)	10	16	25	32	35
CETOP	P05, R05	07	08	10	10+
ISO 4401	05	07	08	10	10+
TYPE	proportional directional valves, pilot operated with LVDT + OBE				
p max	350 bar				
Q max	180 l/min	450 l/min	800 l/min	1800 l/min	2000 l/min

### PERFORMANCES

hysteresis	< 0,5 %				
response time 0 → 100 %	40 ms	35 ms	45 ms	100 ms	100 ms
response time 100 → 0 %	35 ms	30 ms	35 ms	140 ms	140 ms

### NOMINAL FLOW AT 10 BAR ΔP

80, 80/40	■				
100		■			
150, 150/75		■			
200			■		
300, 300/150			■		
350				■	
500, 500/250				■	
800, 800/500				■	
1000					■

### FEATURES ++

EXPLOSION PROOF **DSPE\*K\*** see datasheet 83 510

PILOT / DRAIN **I** internal - **Z** internal pilot with pressure reducing - **E** external

MANUAL OVERRIDE: **CM** boot (on DSPE\* and DSPEG\*) - **CS** screw (on DSPE\* and DSPEG\*) - **CK** knob (on DSPE\* only)

ALTERNATIVE SURFACE FINISHES: **W7** Zinc-Nickel (salt spray resistance up to 600 hours)

DSPE11\* is the high flow version of DSPE10\*, with oversized ports.



MODEL CODE	DDPE5RJ*	DDPE7J*	DDPE8J*	DDPE10J*	DDPE11J*
CATALOGUE	<b>83 350</b>				
SIZE (ND)	10	16	25	32	35
CETOP	R05	07	08	10	10+
ISO 4401	05	07	08	10	10
TYPE	proportional directional valves, pilot operated with LVDT + OBE				
p max	350 bar				
Q max	180 l/min	450 l/min	800 l/min	1600 l/min	2000 l/min

#### PERFORMANCES

hysteresis	< 0,5 %				
response time 0 → 100 %	25 ms	25 ms	55 ms	100 ms	100 ms
response time 100 → 0 %	40 ms	40 ms	50 ms	160 ms	160 ms

#### NOMINAL FLOW at 10 bar Δp

100	■				
120		■			
220		■			
250			■		
400			■		
800				■	
1000					■

#### FEATURES ++

ADDITIONAL SPOOLS for DDPE7J: **RIC** regenerative differential spool specific for regenerative circuits made with external check valve - **X1A** specific for alternate p/Q control typical of plastic injection cycles.

DDPE11J is the high flow version of DDPE10J, with oversized ports.

#### C\*

CLOSED CENTRE

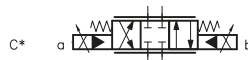

\*SA and \*SB are available for DSPE\* valves only

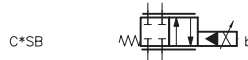
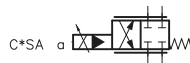

#### A\*

OPEN CENTRE



\*SA and \*SB are available for DSPE\* valves only



#### R\*

REGENERATIVE



not available for DDPE\*J valves and for sizes 05 and 11





**STANDARD ELECTRONICS**  
CONNECTION **K11** 6 pin+PE

- E0** analogue, voltage 0...10V or ±10V
- E1** analogue, current 4...20 mA

OPTIONS: **A** external enable  
**B** internal enable - **C** 0V monitor

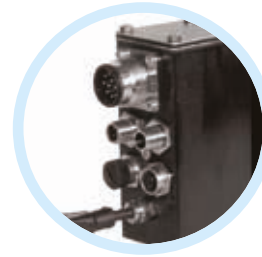

**H** **ELECTRONICS FOR FIELDBUS**  
MAIN CONNECTION **K16** 11 pin+PE

- EC** EtherCAT - **EN** Ethernet /IP - **PN** Profinet - **PL** PowerLink

- E0** analogue, voltage 0...10V or ±10V
- E1** analogue, current 4...20 mA
- FD** full digital version

PORT FOR DIGITAL SENSOR: **1** SSI **2** Encoder  
PORT FOR ANALOGUE S: **1** single or double



MODEL CODE	<b>DXE3J*</b>	<b>DXE5J*</b>
CATALOGUE	<b>85 120</b>	<b>85 220</b>
SIZE (ND)	6	10
CETOP	03	05
ISO 4401	4401-03	4401-05
TYPE	servo-proportional valves direct acting	
p max	350 bar	350 bar
Q max	70 l/min	100 l/min

**PERFORMANCES**

hysteresis	< 0,2%	< 0,2%
response time 0 → 100 %	< 10 ms	< 20 ms
frequency response (± 10%) amplitude at -3dB phase lag at 90°	85 Hz 100 Hz	30 Hz 80 Hz

**NOMINAL FLOW AT Δp 70 bar**

1, 2, 5	■	
10, 20, 40	■	
60		■
100		■

**FEATURES ++**

FAIL SAFE TYPE: **F1** closed centre - **F3** open centre - **FC** cross position  
EXPLOSION PROOF: **K3** compliant with ATEX 2014/34/EU II 3GD

**LZ**

ZERO OVERLAP  
with linear flow  
characteristic

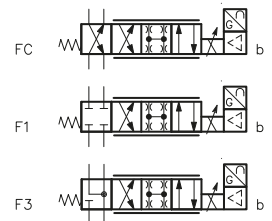





MODEL CODE	DXRE5RJ*	DXRE7J*	DXRE8J*	DXRE10J*	DXRE11J*
CATALOGUE	85 330				
SIZE (ND)	10	16	25	32	35
CETOP	R05	07	08	10	10+
ISO 4401	4401-05-05	4401-07	4401-08	4401-10	4401-10+
TYPE	servo proportional valves pilot operated				
p max	350	350	350	350	350
Q max	180	450	850	1600	3500

#### PERFORMANCES FOR ZERO OVERLAP SPOOLS

response time 0 → 100 %	25	25	30	50	50
frequency response (± 10%) amplitude at -3dB phase lag at 90°	40 60	35 50	30 45	20 35	20 35
100	■				
120		■			
220		■			
250			■		
400			■		
800				■	
1000					■

#### PERFORMANCES FOR POSITIVE OVERLAP SPOOLS

hysteresis	< 0,1 %				
response time 0 → 100 %	20 ms	20 ms	30 ms	120 ms	120 ms

#### FEATURES ++

PILOT / DRAIN: **I** internal - **E** external (always verify application cases on valve datasheet)

ALTERNATIVE SURFACE FINISH: **W7** Zinc-nickel (salt spray resistance up to 600 hours)

DXRE11J is the high flow version of DXRE10J with oversized ports.

### Z\*

ZERO OVERLAP  
with linear flow  
characteristic



### C\*

CLOSED CENTRE  
with linear flow  
characteristic

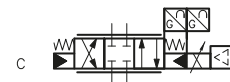

### A\*

OPEN CENTRE  
with linear flow  
characteristic



# ACTUATORS ISO 6020-2 CYLINDERS

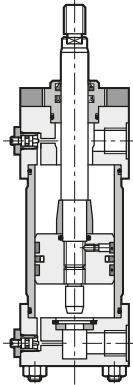

MODEL CODE	<b>HC2</b>
CATALOGUE	<b>71 000</b>
TYPE	Hydraulic actuators according to ISO 6020-2
p max continuous	160 bar
p max operating	210 bar
p peak	250 bar
stroke	max 5000 mm
speed	standard 0,5 m/s low friction 15 m/s

**FEATURES**

SINGLE / DOUBLE ROD available  
**HCK2** ex-proof version available, see catalogue.

MOUNTING STYLE: **A** flange, front - **B** flange, rear - **C** clevis, female - **D** clevis, male - **F** spheric swivel - **G** feet - **H** swinging, front - **L** swinging, mid - **N** swinging, rear - **P** tie rods, front - **Q** tie rods, back - **R** tie rods, front and back - **T** threaded holes, front - **U** threaded holes, rear

SENSORS: As option. **FP** PNP proximity sensor - **FMR** reed magnetic sensors - **FMH** Hall effect magnetic sensors

ALTERNATIVE ROD THREAD: **W** female - **X** male, light - **Y** female, light

SEALS: **K** standard nitrile+polyurethane - **M** low friction nitrile+PFTE - **V** high temperature / viton+PFTE

CUSHIONING: **0** without - **1** front - **2** back - **3** both front and back

BREATHERS: **0** without - **S** with, both front and back

CONNECTIONS POSITION: four position available, see related datasheet.

**ROD / BORE AVAILABILITY**

ROD diameter (mm)	BORE (mm)									
	25	32	40	50	63	80	100	125	160	200
12	■									
14		■								
18	■	■	■							
22		■	■	■						
28			■	■	■					
36				■	■	■				
45					■	■	■			
56						■	■	■		
70							■	■	■	
90								■	■	■
110									■	■
140										■

**A B**

flanged  
ME5  
ME6

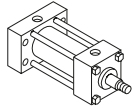
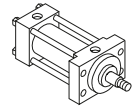

**C D**

clevis  
MP1  
MP3

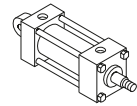
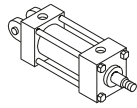

**F**

swivel joint  
MP5

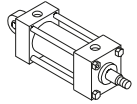

**G**

feet  
MS2

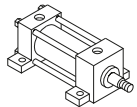

**H L N**

swinging  
MT1  
MT2  
MT4

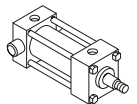
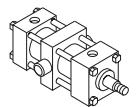
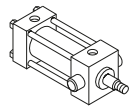

**P Q R**

tie rods  
MX1  
MX2  
MX3

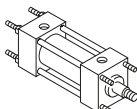

**T U**

threaded holes  
MX5  
MX6

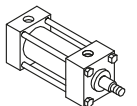
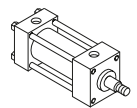

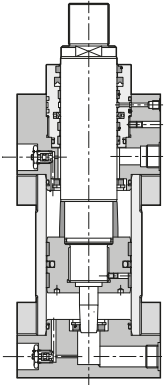

MODEL CODE	<b>HC3</b>
CATALOGUE	<b>71 200</b>
TYPE	Hydraulic actuators according to ISO 6022
p max continuous	250 bar
p max operating	320 bar
stroke	max 5000 mm
speed	standard 0,5 m/s low friction 15 m/s

### ■ FEATURES

SINGLE / DOUBLE ROD available

**HCK3** ex-proof version available, see catalogue.

MOUNTING STYLE: **A** flange, front - **B** flange, rear - **D** clevis, male -

**F** spheric swivel - **L** swinging, mid

SENSORS: As option. **FP** PNP proximity sensor - **FMR** reed magnetic sensors - **FMH** Hall effect magnetic sensors

ALTERNATIVE ROD THREAD: **W** female

SEALS: **K** standard nitrile+polyurethane - **M** low friction nitrile+PFTE - **V** high temperature / viton+PFTE

CUSHIONING: **0** without - **1** front - **2** back - **3** both front and back

BREATHERS: **0** without - **S** with, both front and back

DRAIN: **0** without - **E** external, with port on the front end

CONNECTIONS POSITION: four position available, see related datasheet.

**A B**

flanged  
MF3  
MF4

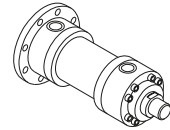
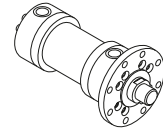

**D**

clevis  
MP3

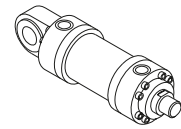

**F**

swivel joint  
MP5

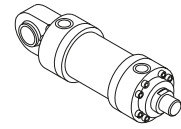

**L**

swinging  
MT4

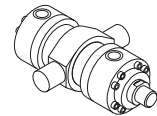

### ■ ROD / BORE AVAILABILITY

(\*) bores not foreseen in the ISO 6022 standard

		BORE (mm)														
		50	63	80	100	125	140*	160	180*	200	250	320	400			
ROD diameter (mm)	32	36	■													
	40	45		■												
	50	56			■											
	63	70				■										
	80	90					■									
	90	100						■								
	100	110							■							
	110	125								■						
	125	140									■					
	160	180										■				
	200	220											■			
250	280												■			

# ACTUATORS SERVOCYLINDERS

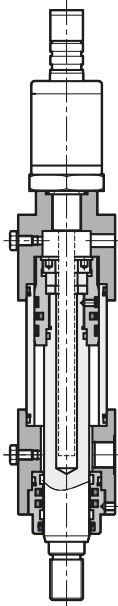

MODEL CODE	HCX*	HCX3*
CATALOGUE	71 100	71 300
TYPE	Servocylinders	
	according to ISO 6020-2	according to ISO 6022
p max continuous	160 bar	250 bar
p max operating	210 bar	320 bar
max stroke	5000 mm	5000 mm
max speed	standard 0,5 m/s	low friction 15 m/s
bore	Ø40 mm to Ø200 mm	Ø50 mm to Ø400 mm
rod	Ø22 mm to Ø140 mm	Ø32 mm to Ø280 mm

### FEATURES

SINGLE / DOUBLE ROD available

MOUNTING STYLE: **A** flange, front - **G** feet, front - **H** swinging, front - **L** swinging, mid - **N** swinging, rear - **P** tie rods, front - **Q** tie rods, back

SENSORS: Wide range of transducers available, **M3** 0 ÷ 10 V - **M3A** ±10 V **M2** 4 ÷ 20 mA - **M8** 20 ÷ 4 mA - **M6** CAN-open - **M1** SSI, digital **MP** ProfiBus. Further types upon request.

VALVE MOUNTING SURFACE: **04** ISO 10372 (servovalves) - **3** ISO 4401-03 **5** 4401-05 - **9** custom

SEALS: low friction nitrile+PFTE or **V** high temperature viton+PFTE

## A

flanged  
ME5

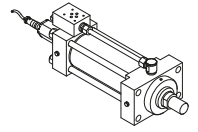

## G

feet  
MS2

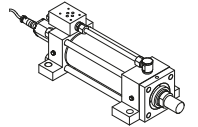

## H L N

swinging  
MT1  
MT2  
MT4

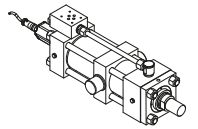

## P Q R

tie rods  
MX1  
MX2  
MX3

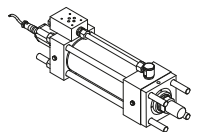

### ROD / BORE AVAILABILITY

		BORE (mm)							
		40	50	63	80	100	125	160	200
ROD diameter (mm)	22	■	■						
	28	■	■	■					
	36		■	■	■				
	45			■	■	■			
	56				■	■	■		
	70					■	■	■	
	90						■	■	■
	110							■	■
140								■	

MODEL CODE	EDC	EDM-M*	EDM-M*IOI	EDM-J	EWM-A-SV	EWM-A-PV
CATALOGUE	89 120	89 252	89 251	89 255	89 610	89 620
TYPE	single amplifier	for proportional valves in open loop		for proportional valves in closed loop without OBE	for servovalves	for proportional valves in open loop
MOUNTING	on-board	rail mounting			rail mounting	
configuration	by hand/software	software			by hand	software
IP grade	IP 65/67	IP 20			IP 20	
power supply	10 - 30 V DC	9 - 32 V DC	19 - 30 V DC	19 - 30 V DC	18 - 30 V DC	12 - 30 V DC
reference signal	0 ÷ 10 V 0 ÷ 5 V 4 ÷ 20 mA	0 ÷ 10 V ± 10 V 4 ÷ 20 mA	via IO-Link	0 ÷ 10 V ± 10 V 4 ÷ 20 mA	± 10 V	0 ÷ 10 V; ± 10 V 4 ÷ 20 mA 8 digital binary

#### ■ EDC

MAX CURRENT: **1** 860 mA - **2** 1200 mA - **3** 1600 mA - **4** 1880 mA - **5** 2600 mA

PWM: **1** 100 Hz - **2** 200 Hz - **3** 300 Hz - **4** 400 Hz - **5** 500 Hz

#### ■ EDM-M\*, EDM-M\*IOI

VERSION: **1** for single solenoid valves - **2** for dual solenoid valves - **3** 2 channels - independent control of 2 solenoids

MAX CURRENT: **0** 780 mA - **1** 860 mA - **2** 1200 mA - **3** 1600 mA - **4** 1880 mA - **5** 2600 mA - **6** 1530 mA;

PWM: **1** 100 Hz - **2** 200 Hz - **3** 300 Hz - **4** 400 Hz

#### ■ EDM-J

For valves with feedback type F or R.

#### ■ EWM-A-SV

CONFIGURATION: DIL switches and trimmers inside the casing. 5 DIL switches allow to set a current value from 0 to 200 mA, with increments of 10 mA. (10, 20, 30 ... etc.).

#### ■ EWM-A-PV

CARD FUNCTIONS: To be set via software: **A-PV** analogue ± 10V or 4 ÷ 20 mA (one channel, 2 solenoids) - **2A-PV** analogue 0 ÷ 10V or 4 ÷ 20 mA (two independent channels) - **D-RI** digital, 8 pre-set values, selectable by 3 digital inputs (8 binary targets). For both single or dual solenoids proportional valve either.

MODEL CODE	EWM-S-AA	EWM-ST-AA	EWM-S-AD	EWM-SP-DAD	EWM-SP-DAD
CATALOGUE	89 410	89 411	89 420	89 440	89 445
TYPE	card for closed loop systems				
CONTROL	position controller			position, pressure, both	
MOUNTING	rail mounting				
IP grade	IP 20				
power supply	12 - 30V DC	12 - 30V DC	24 - 30 V DC	24 - 30 V DC	24 - 30 V DC
reference signal	analogue	analogue	analogue	Profibus DP	ProfiNet / EtherCat

#### OUTPUT

E	± 10 V differential 4 ÷ 20 mA	4 ÷ 20 mA	± 10 V differential 4 ÷ 20 mA	± 10 V differential 4 ÷ 20 mA	± 10 V differential 4 ÷ 20 mA
M*	-	500 ÷ 2600 mA	-	-	-

#### FEEDBACK

voltage 0 ÷ 10	■	■	■	■	■
current 4 ÷ 20 mA	■	■	■	■	■
digital, SSI			■	■	■

#### ■ EWM-S-AA, EWM-ST-AA

Position controller for systems with analogue sensor. The EWM-ST-AA has been designed for steam turbine applications, with dedicated parameters.

#### ■ EWM-S-AD

Position controller for systems with digital position feedback, it can work with analogue also.

#### ■ EWM-SP-DAD

Position controller for closed loop systems for position, pressure or both position and pressure control. It works with a digital sensor for positioning, and one or two analogue sensors for pressure sensing. Embedded interface for Profibus DP or ProfiNet communication.

All these modules have to be programmed via software. USB port on front panel. Free download of the software EWMPC and PLC configuration files from our site. Sampling time of the control loop: 1 ms.

# ELECTRONICS

## SYNCHRONIZATION



MODEL CODE	EWM-MS-AA	EWM-2SS-DAD	EWM-2SS-DAD
CATALOGUE	89 450	89 470	89 475
TYPE	card for closed loop systems		
CONTROL	synchro 2 / 6 axes	synchro 2 axes	synchro 2 axes
MOUNTING	rail mounting		
IP grade	IP 20		
power supply	12 - 30 V DC	24 V DC	24 V DC
reference signal	0 ÷ 10 V 4 ÷ 20 mA	Profibus DP	ProfiNet / EtherCat

### OUTPUT

E	± 10 V differential 4 ÷ 20 mA	± 10 V differential 4 ÷ 20 mA	± 10 V differential 4 ÷ 20 mA
M2	500 ÷ 2600 mA	-	-

### FEEDBACK

voltage 0 ÷ 10	■	■	■
current 4 ÷ 20 mA	■	■	■
digital, SSI		■	■

### ■ EWM-MS-AA

FUNCTIONS: MASTER/MASTER position control (2 axes); MASTER/SLAVE position control, for up 6 axes. If the synchronisation controller is active, it overrides the position control process. INDEPENDENT POSITIONING by separate commands position. One card per axis to be driven is needed.

### ■ EWM-2SS-DAD SYSTEM

2 axes synchronized positioning via Fieldbus (Profibus, ProfiNet, EtherCat). Fieldbus card embedded. MASTER/SLAVE or MASTER/MASTER. Motion profile (speed and position) via Fieldbus. One card per system (2 axes are needed).

All these modules have to be programmed via software. USB port on front panel. Free download of the software EWMPC and .GSD file from our site.

## PRESSURE



MODEL CODE	EWM-P-AA	EWM-PQ-AA
CATALOGUE	89 500	89 550
TYPE	card for closed loop systems	
CONTROL	pressure	pressure + flow
MOUNTING	rail mounting	
IP grade	IP20	
power supply	12 - 30 V DC	
reference / p signal	0 ÷ 10 V 4 ÷ 20 mA	0 ÷ 10 V 4 ÷ 20 mA
Q input	0 ÷ 10 V 4 ÷ 20 mA	±10 V 4 ÷ 20 mA

### OUTPUT

E	-	±10 V differential 4 ÷ 20 mA
M1	500 ÷ 2600 mA	-

### FEEDBACK

voltage 0 ÷ 10	■	■
current 4 ÷ 20 mA	■	■

### ■ EWM-P-AA

For proportional pressure reducing and pressure relief valves. The power amplifier is embedded. The reference signal is transferred directly to the pressure valve and the closed loop compensates just the linearity failures.

### ■ EWM-PQ-AA

For zero-overlap control valves. The p/Q controller automatically switches between flow and pressure control modes to assure the set point limits of the differential pressures has not to exceed.

All these modules have to be programmed via software. USB port on front panel. Free download of the EWMPC software from our site. Sampling time of the control loop: 1 ms.



MODEL CODE	EDCPC	LINPC-USB*
CODE	<b>3898301001</b>	<b>89 850</b>
TYPE	software kit	test device
for	ECL, ECF, EDC	proportional valves with LIN-bus interface type G, J, X series 20, 30-33

**EDCPC**

The kit is made of software CD, drivers, cable USB/serial port and an adaptor with serial port to be plugged on the amplifier.

**LINPC-USB\***

VERSIONS: **5** 5 poles M12 - **7** 6 poles + PE - **12** 11 poles + PE

The kit contains a test device with embedded connection cable and the USB cable for connection to the PC.

The dedicated software of each valve series is available for free download from our website.

No additional power supply is required: the device uses the supply source from the system cable.

MODEL CODE	EWMPC/20	EBC	SMARTMANAGER
TYPE	software download	software download	software download
for	EWM cards series 20/22 proportional valves	proportional valves with LIN-bus interface type G, J, X series 30 and 31 EDM-M, EDM-J cards series 30 and 31	EDM-M* cards series 40

**EWMPC**

Software for parameterization of EWM series 20 cards. Compliant with OS Windows 7, 8 and 10. Card connection via USB port, with USB 2.0 cable A – B (standard USB printer cable).

**EBC**

Software for parameterization and diagnostic of:

- Diplomatic proportional valves with LIN-bus interface type G, J and X, series 30 and 31. To be combined with LINPC tool.
- Diplomatic EDM-M and EDM-J cards, series 30.

Compliant with OS Windows 7, 8 and 10.

Card connection via USB port, with USB 2.0 cable A – micro B.

**SMARTMANAGER**

Software for parameterization of Diplomatic EDM-M\* cards, series 40.

Compliant with Microsoft OS Windows.

Card connection via USB port, with USB 2.0 cable A – micro B.



MODEL CODE	PM RQ3*	PM RQ5*	PM RQ7*	PM RQA5*	PM SZ3*	PM SZ5*
CATALOGUE	51 000					
PATTERN	ISO 6264-06	ISO 6264-08	ISO 6264-10	-	ISO 5781-06	ISO 5781-08
TYPE	for pressure valves - ports on rear					
p max	350 bar	350 bar	350 bar	350 bar	320 bar	320 bar
<b>PORT THREAD</b>						
P, E	1/2" BSP	1" BSP	1 1/4" BSP	3/4" BSP	1/2" BSP	1" BSP
T	3/4" BSP	1 1/4" BSP	1 1/4" BSP	3/4" BSP		
X		1/4" BSP		-	1/4" BSP	
Y	-	-	-	-	1/4" BSP	
U	-	-	-	3/4" BSP	1/2" BSP	1" BSP

MODEL CODE	PM RPC1*	PM RPC2*	PM RPCQ2*	PM RPC3*	PM RPCQ3*
CATALOGUE	51 000				
PATTERN	ISO 6263-03	ISO 6263-06-05	ISO 6263-06-07	ISO 6263-07-09	ISO 6263-07-11
TYPE	for flow control valves				
p max	250 bar	320 bar	320 bar	250 bar	250 bar
<b>PORT THREAD</b>					
A, B	3/8" BSP	-			
E, U	-	1/2" BSP	1/2" BSP	1" BSP	1" BSP
T	-	-	1/2" BSP		1" BSP
X			1/4" BSP		1/4" BSP
<b>PORT POSITION</b>					
rear	■	■	■	■	■
side	■				



MODEL CODE	PM MD	PM D4	PM E4	PM E07	PM E5	
CATALOGUE	51 000					
PATTERN	ISO 4401-03	ISO 4401-05	CETOP P05	ISO 4401-07	ISO 4401-08	
TYPE	for directional valves					
p max	350 bar	350 bar	320 bar	350 bar	350 bar	
<b>PORT THREAD</b>						
A, B, P, T	3/8" BSP	3/4" BSP	1/2" BSP	3/4" BSP	1" BSP	1 1/2" BSP
X, Y	-	-	-	1/4" BSP	1/4" BSP	1/4" BSP
<b>PORT POSITION</b>						
rear	■	■		■	■	
side	■		■	■	■	■



MODEL CODE	PE-MD	PE- C/PA	PE- C/PB	PE-D4/M	PC-D4
CATALOGUE	59 000				
SIZE ISO 4401	03	03	03	05	05 to 03
TYPE	blanking	cross PA /BT	cross PB/AT	blanking	conversion
p max	350 bar				





MODEL CODE	P2D	P2T	P4D-D*	P4D*
CATALOGUE	52 000		53 000	
FOR SIZE	ISO 4401-03		ISO 4401-03	ISO 4401-05
TYPE	modular subplates			
Q max	50 l/min		100 l/min	100 l/min
<b>PORT SIZE</b>				
P, A, B, T low	3/8" BSP		see options	
T up	1/2" BSP			
material	cast iron			
stations	1	2	1	1

#### ■ P2\* FEATURES ++

OPTIONS: **F** threaded ports, additional T port - **I** intermediate type with threaded bores and additional T port - **Z** designed for installation of an ISO 4401-03 pressure reducing valve  
**M\*** built-in pressure relief valve

#### ■ P4\* FEATURES ++

**D3** mounting surface ISO 4401-03 (CETOP 03) , A and B side ports 3/8" BSP - **D3P** mounting surface ISO 4401-03 (CETOP 03) and A and B rear ports 1/2" BSP - **F** mounting surface ISO 4401-05 (CETOP 05) , A and B side ports 1/2" BSP - **P** mounting surface ISO 4401-05 (CETOP 05) and A and B rear ports 3/8" BSP - **M\*** built-in pressure relief valve (4 ranges available)



MODEL CODE	P2A*	P2X*
CATALOGUE	52 100	52 110
FOR SIZE	ISO 4401-03	
TYPE	multi-station manifold	
PORTS	side	rear
p max	210 bar	350 bar
Q max	50 l/min	100 l/min
<b>PORT THREAD</b>		
A, B	3/8" BSP	1/2" BSP
P, T	1/2" BSP	1/2" BSP
material	aluminium	cast iron
stations	2 to 8	2, 4 or 6

#### ■ P2X\* FEATURES ++

**M** with seat for pressure relief cartridge valve. See related datasheet for details.

# ACCESSORIES FILTERS



MODEL CODE	FSI	FST	FPH	FPM	FPHM	FRT	FRC
CATALOGUE	95 100	95 110	95 210	95 220	95 230	95 150	95 160
TYPE	suction filters		pressure filters			return filters	
mounting	submerged	flanged	online		stackable	above reservoir flanged	above reservoir online
differential p max	1 bar	1 bar	20 bar 210 bar (cart. 5 µm)	20 bar	210 bar	3 bar	3 bar
working pressure	-	-	420 bar	210 bar	320 bar	3 bar	7 bar

### FILTRATION

metal wire mesh 90 µm	■	■	-				
fiber 05 µm	-	-	■	■	■		
fiber 10 µm	-	-	■	■	■	■	
fiber 25 µm	-	-	■	■	■	■	■
paper 10 µm	-	-				■	■
paper 25 µm	-	-					■

### AVAILABLE SIZES / FLOWRATE RANGE (l/min)

ISO 4401-03	-	-	-	-	12 - 16	-	-
ISO 4401-05	-	-	-	-	22 - 28	-	-
3/8" BSP	9	-	-	-	-	-	-
1/2" BSP	14	-	10 - 33	25 - 60	-	18 - 30	-
3/4" BSP	25	-	19 - 65	35 - 80	-	50 - 85	65 - 75
1" BSP	45	-	40 - 105	40 - 100	-	65 - 130	-
1 1/4" BSP	75	70	88 - 230	-	-	150 - 210	-
1 1/2" BSP	100	-	120 - 320	-	-	160 - 290	180 - 200
2" BSP	160	-	-	-	-	280 - 430	-
2 1/2" BSP	250	-	-	-	-	-	-
3" BSP	350	-	-	-	-	-	-
2 1/2" SAE		100					
3" SAE		200					
4" SAE	-	300	-	-	-	-	-

### ACCESSORIES

Clogging indicator, visual		VS/10	VPM/10	VPM/10	VM/10	VR/10	VR/10
Clogging indicator, electric		ES/10	-	-	-	ER/11	ER/11
Clogging indicator, visual+electric		-	EPM/10	EPM/10	EM/10	-	-
Filter element (spare part)		FSTE	FPHE	FPME	FPHME	FRTE	FRCE

### FEATURES++

BYPASS VALVE: FRT, FRC pressure opening 1,7 bar. FPH, FPM: **O** without - **B** with (Bypass valve not available with cartridge fiber 05 µm).

FILTER ELEMENT: Available as spare parts too for all filters. FRC, FPM : **S** standard - **L** long lasting



MODEL CODE	M63*R	M63*PF
CATALOGUE	91 000	
TYPE	pressure gauges - according to EN 837-1	
mounting	1/4" BSP radial connection	1/4" BSP flange connection
p max	end scale value for short period	

#### ■ FEATURES++

GAUGE SCALE: **006** 0 ÷ 6 bar - **010** 0 ÷ 10 bar - **016** 0 ÷ 16 bar - **025** 0 ÷ 25 bar - **060** 0 ÷ 60 bar - **100** 0 ÷ 100 bar  
**160** 0 ÷ 160 bar - **250** 0 ÷ 250 bar - **400** 0 ÷ 400 bar.

**PF** Flange connection available from 060 to 400 only.



MODEL CODE	PS*2	PS*4	PS*6	PS*8
CATALOGUE	91 100			
TYPE	pressure switch, piston			
p max	350 bar		650 bar	
p adjustment range	3 - 35 bar	6 - 140 bar	10 - 350 bar	20 - 630 bar

#### ■ FEATURES++

MOUNTING **P** ISO 4401-03 subplate - **T** threaded port 1/4" BSP



MODEL CODE	PTH			
CATALOGUE	92 100			
TYPE	pressure transmitters			
p nom	40 bar	100 bar	250 bar	400 bar
p max	120 bar	300 bar	750 bar	1000 bar
p burst	280 bar	500 bar	1000 bar	2000 bar
hysteresis	± 0.2% of nominal pressure			
accuracy	0.5% of nominal pressure			
TEB total error band	± 1.75% of nominal pressure			

#### ■ FEATURES++

HYDRAULIC CONNECTION: threaded port 1/4" BSP with seal (DIN 3869)

OUTPUT SIGNAL: **E1** current 4 ÷ 20 mA - **E0** voltage 0 ÷ 10 V;

upon request: **E2** voltage 0 ÷ 5 V - **E5** voltage 0.5 ÷ 4.5 V ratiometric

ELECTRICAL CONNECTION: **K10** mini DIN 43650 - **K12** M12 - 4 pin



MODEL CODE	<b>EHU 3007</b>	<b>EHU 3007</b>	<b>EHU 1414</b>	<b>SUT00S 3016</b>	<b>SUT00D 6021</b>	<b>SUT00D 8021</b>
CATALOGUE	<b>96 500</b>		<b>96 501</b>	<b>96 510</b>		
TYPE	hybrid power unit			hybrid power unit		
p max	70 bar	70 bar	135 bar	160 bar	210 bar	210 bar
Q max (l/min)	28.5	28.5	14.7	24.3	60	82
supply voltage	AC 3-phase 380V...460 V - 50 / 60 Hz (±10%)			AC 3-phase 380V...480 V - 50 / 60 Hz (±10%)		
motor capacity	2.8 kW			5 kW	5 kW	7 kW
noise level	58...70 dB			52...70 dB	57...74 dB	57...77 dB

#### TANK CAPACITY

none	-	■	■	■	■	■
18 l	■	-	-	-	-	-
45 l	-	■	■	-	-	-
100 l	-	-	-	■	■	■

#### FEATURES++

Equipped with IPM motor and cooler; BSPP ports; accessories to be ordered separately; Hybrid-win software for configuration and monitoring can be downloaded for free from the website; cable kit available.

#### EHU CAT. 96 501, SUT

Deliverable with:

- fixing frame, no tank.
- tank, equipped with suction filter, level switch and customizable plate.
- tank, equipped with suction filter, level switch, return filter with clogging indicator and 3-station manifold.

#### SUT00D

SUT00D are equipped with a double pump. The primary pump delivers high pressure and limited flow. When the flow rate request is higher than the flow rate that can be supplied by the primary pump, the second pump is also activated, guaranteeing the required flow (at lower pressure). The transition from single to combined operation is done by a solenoid valve.

#### SUT high accuracy - with single pump

MODEL CODE	<b>8018</b>	<b>13018</b>	<b>15018</b>	<b>20018</b>	<b>5021</b>	<b>13021</b>	<b>5025</b>
CATALOGUE	<b>96 520</b>						
TYPE	hybrid power unit						
p max	176 bar				206 bar		250 bar
Q max (l/min)	80	130	150	200	50	130	50
controller supply voltage	AC 3-phase 380...440 V 50/60 Hz (-20% +10%)						
cooling fan supply voltage	AC 1-phase 215...245 V 50/60 Hz						
motor capacity	11 kW	15 kW		22 kW	11 kW	15 kW	

#### SUT high accuracy - with double pump

MODEL CODE	<b>8021</b>	<b>13021</b>	<b>15021</b>	<b>20021</b>	<b>26021</b>	<b>30021</b>	<b>8025</b>	<b>13025</b>	<b>20025</b>	<b>22028</b>	<b>30028</b>
CATALOGUE	<b>96 520</b>										
TYPE	hybrid power unit										
p max	206 bar					250 bar			280 bar		
Q max (l/min)	80	130	150	200	260	300	80	130	200	220	300
controller supply voltage	AC 3-phase 380...440 V 50/60 Hz (-20% +10%)										
cooling fan supply voltage	AC 1-phase 215...245 V 50/60 Hz									AC 1-phase 200...240 V 50/60 Hz	
motor capacity	11 kW	15 kW			37 kW		11 kW	15 kW	22 kW	37 kW	

#### FEATURES++

HYSTERESIS AND LINEARITY: ≤ 1% ; INPUT: analogue or digital





MODEL CODE	<b>AKW*A-500</b>									
CATALOGUE	<b>96 610</b>									
TYPE	inverter controlled chiller									
cooling capacity	1.4 kW	3.2 kW	4.3 kW	5.6 kW	9.0 kW	1.8 kW	3.5 kW	4.5 kW	5.8 kW	9.2 kW
cooling media	water / ethylene glycol solution									
supply voltage	AC 3-phase 380/400/415 V 50/60 Hz (+-10%)									
max power consumpt.	1.56 kW	2.11 kW	2.36 kW	3.53 kW	4.97 kW	0.81 kW	1.36 kW	1.60 kW	2.40 kW	3.84 kW
	3 A	3.9 A	4.3 A	6.3 kW	9.5 A	1.6 A	2.6 A	3 A	3.1 A	3.1 A
<b>PUMP / TANK</b>										
with	■	■	■	■	■	-	-	-	-	-
without	-	-	-	-	-	■	■	■	■	■



## LOOKING FOR CAD MODELS ?

3D & 2D CAD models of most of our products are available on line in our website.

To download a file you have to create an account. This action is required only once and is completely **free of charge**.

Once logged in, a **configurator** will guide you through the selection of the right version of the component you are interested in.

You can **download** for SolidWorks, Solid Edge, Autodesk Inventor, Autocad, CATIA, NX, Creo, and many others CAD systems.

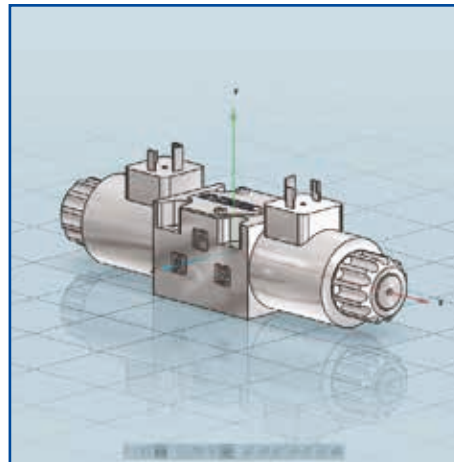

Visit our **3D catalogue** by scanning this QR code with your smartphone



or on the web, at:

<https://diplomatic.partcommunity.com>

# DIPLOMATIC GROUP AT A GLANCE



HQ

Parabiago  
(Milan, Italy)



15

Plants  
worldwide



650 +

Employees



5,000 +

Customers



162 Mln €

Group consolidated  
turnover

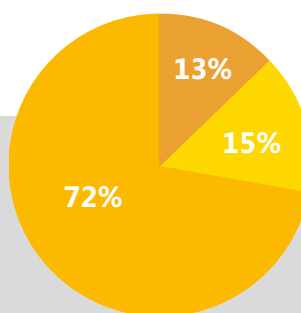

Turnover  
geographic area

- Europe 72%
- Asian Pacific 15%
- America 13%

# DIPLOMATIC

MOTION SOLUTIONS

a member of **DAIKIN** group



Our sales network covers over 55 countries in the world. With a partner located at each corner of the globe, we can be always at your side.

The number of partners, distributors sales and assistance points is constantly growing.

To find your closest distributor, please visit our website at:

[www.diplomaticmotionsolutions.com/en/diplomatic-distributors.html](http://www.diplomaticmotionsolutions.com/en/diplomatic-distributors.html)

or simply scan this QR code



## DIPLOMATIC MS Spa

Via Mario Re Depaolini, 24 | 20015 Parabiago (MI) - Italy

T +39 0331 895111 | E [vendite.ita@diplomatic.com](mailto:vendite.ita@diplomatic.com) | [sales.exp@diplomatic.com](mailto:sales.exp@diplomatic.com)

[diplomaticmotionsolutions.com](http://diplomaticmotionsolutions.com)

product overview - industrial hydraulics - 00810/123  
© Diplomatic MS Spa 2023