



DSH3L

LEVER OPERATED DIRECTIONAL CONTROL VALVE

SERIES 10

**MOUNTING SURFACE
ISO 4401-03**

p max (see performances table)
Q nom **60 l/min**

OPERATING PRINCIPLE

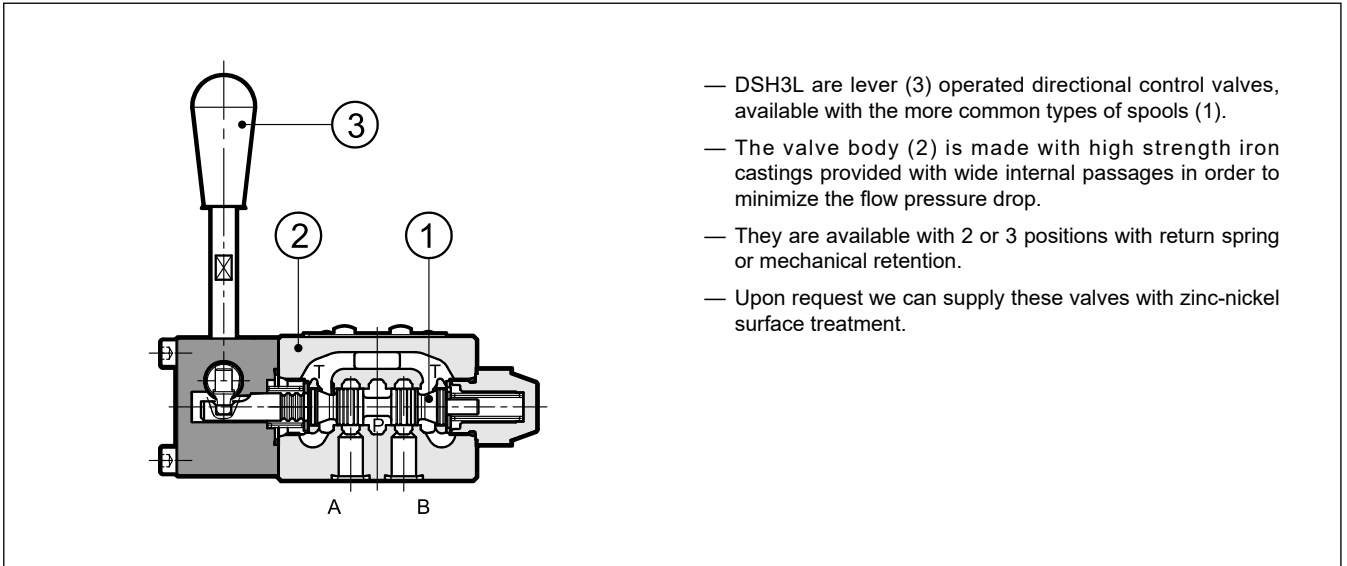

PERFORMANCES (with mineral oil of viscosity of 36 cSt at 50°C)

Maximum working pressure: - P - A - B ports - T port	bar	350 210
Nominal flow rate	l/min	60
Ambient temperature range	°C	-20 / +60
Fluid temperature range	°C	-20 / +80
Fluid viscosity range	cSt	10 ÷ 400
Fluid contamination degree		according to ISO 4406:1999 class 20/18/15
Recommended viscosity	cSt	25
Mass	kg	1.4

1 - IDENTIFICATION CODE

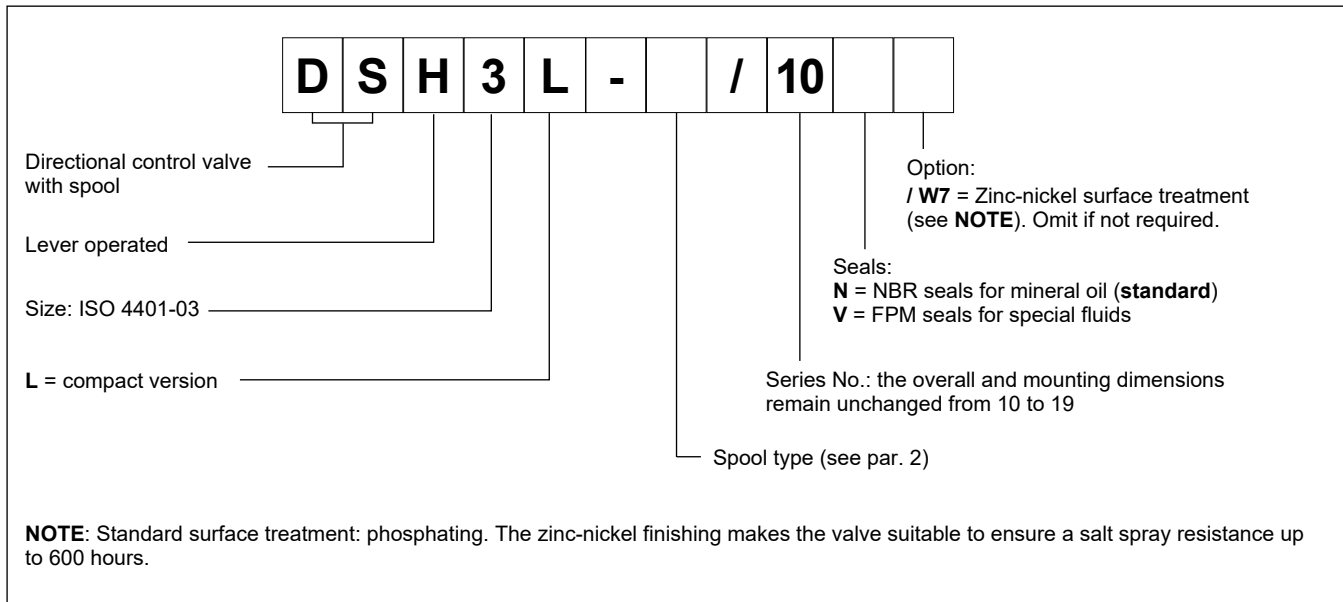

2 - SPOOL TYPE

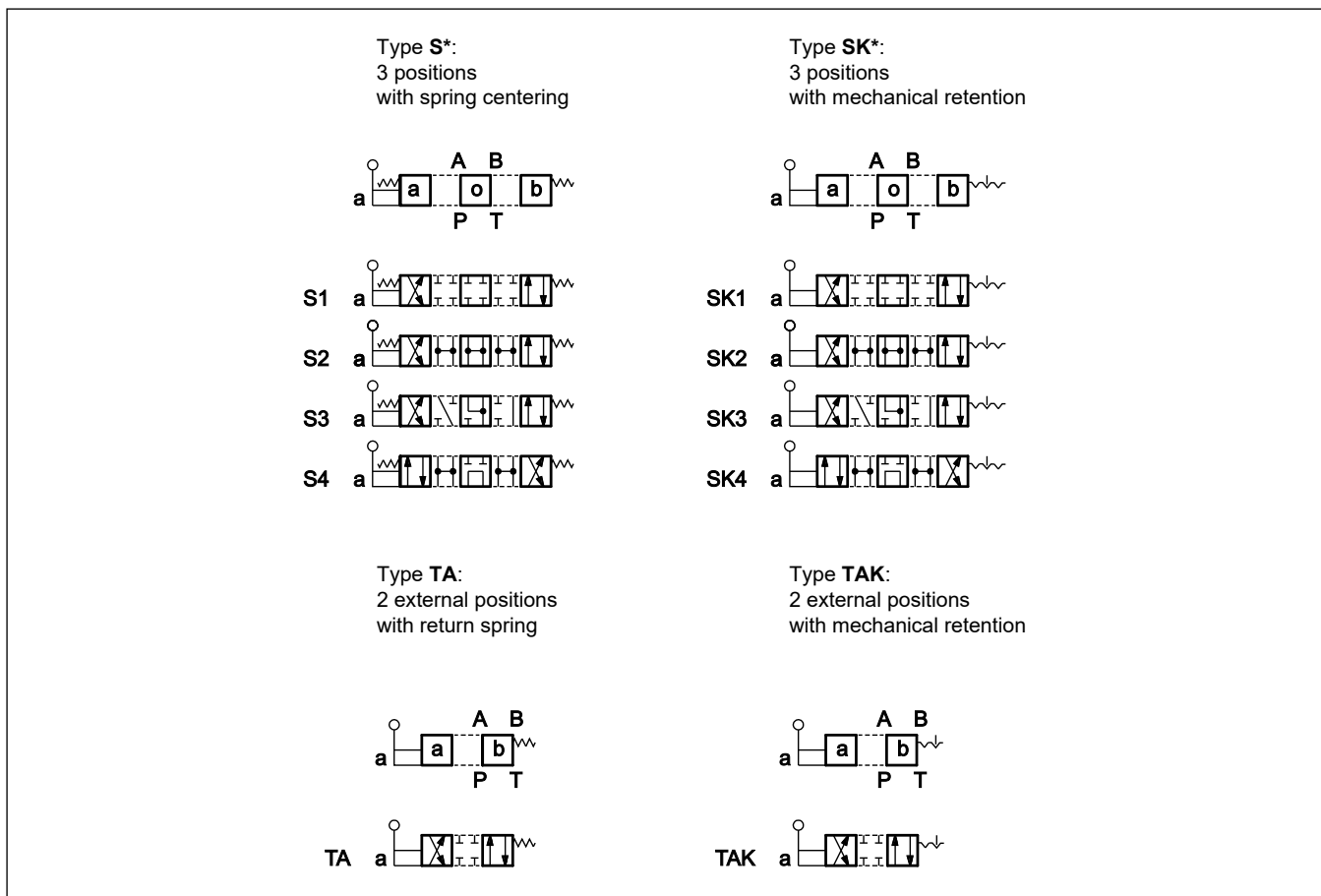

3 - HYDRAULIC FLUIDS

Use mineral oil-based hydraulic fluids HL or HM type, according to ISO 6743-4. For these fluids, use NBR seals (code N). For fluids HFDR type (phosphate esters) use FPM seals (code V). For the use of other fluid types such as HFA, HFB, HFC, please consult our technical department. Using fluids at temperatures higher than 80 °C causes a faster degradation of the fluid and of the seals characteristics. The fluid must be preserved in its physical and chemical characteristics.

4 - PRESSURE DROPS Δp -Q (values obtained with viscosity 36 cSt at 50 °C)

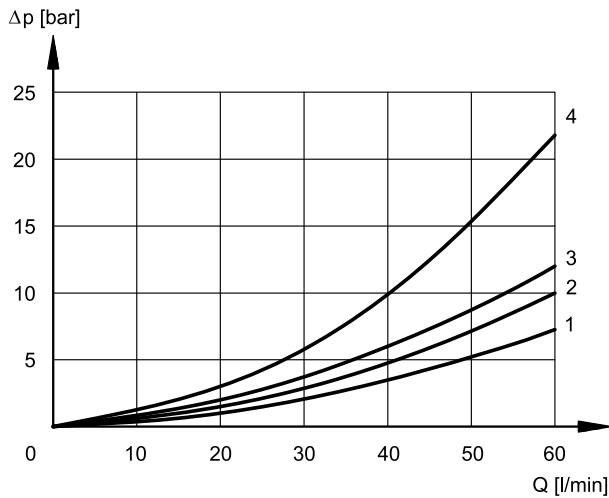

VALVE IN ACTUATED POSITION

SPOOL TYPE	FLOW DIRECTION			
	P→A	P→B	A→T	B→T
	CURVES ON GRAPH			
S1, SK1	2	2	3	3
S2, SK2	1	1	3	3
S3, SK3	3	3	1	1
S4, SK4	4	4	4	4
TA, TAK	3	3	3	3

VALVE IN NORMAL POSITION

SPOOL TYPE	FLOW DIRECTION				
	P→A	P→B	A→T	B→T	P→T
	CURVES ON GRAPH				
S2, SK2					2
S3, SK3			3	3	
S4, SK4					3

5 - OPERATING LIMITS

The curves define the flow rate operating fields according to the valve pressure of the different versions.

The values have been obtained according to ISO 6403 norm, with mineral oil viscosity 36 cSt at 50 °C and filtration ISO 4406:1999 class 18/16/13.

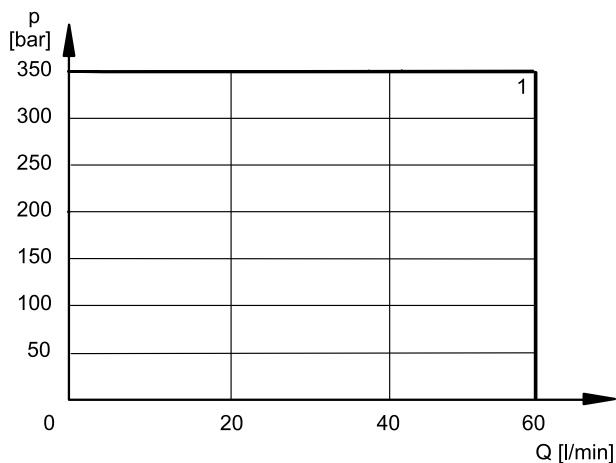

SPOOL TYPE	CURVE	
	P→A	P→B
S1, SK1	1	1
S2, SK2	1	1
S3, SK3	1	1
S4, SK4	1	1

SPOOL TYPE	CURVE	
	P→A	P→B
TA, TAK	1	1

6 - INSTALLATION

Configurations with centering and return springs can be mounted in any position; valves with mechanical detent must be mounted with the longitudinal axis horizontal.

Valve fixing is by means of screws or tie rods, with the valve mounted on a lapped surface, with values of planarity and smoothness that are equal to or better than those indicated in the drawing. If the minimum values of planarity and/or smoothness are not met, fluid leakage between valve and mounting surface can easily occur.

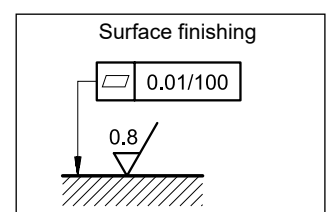

7 - OVERALL AND MOUNTING DIMENSIONS

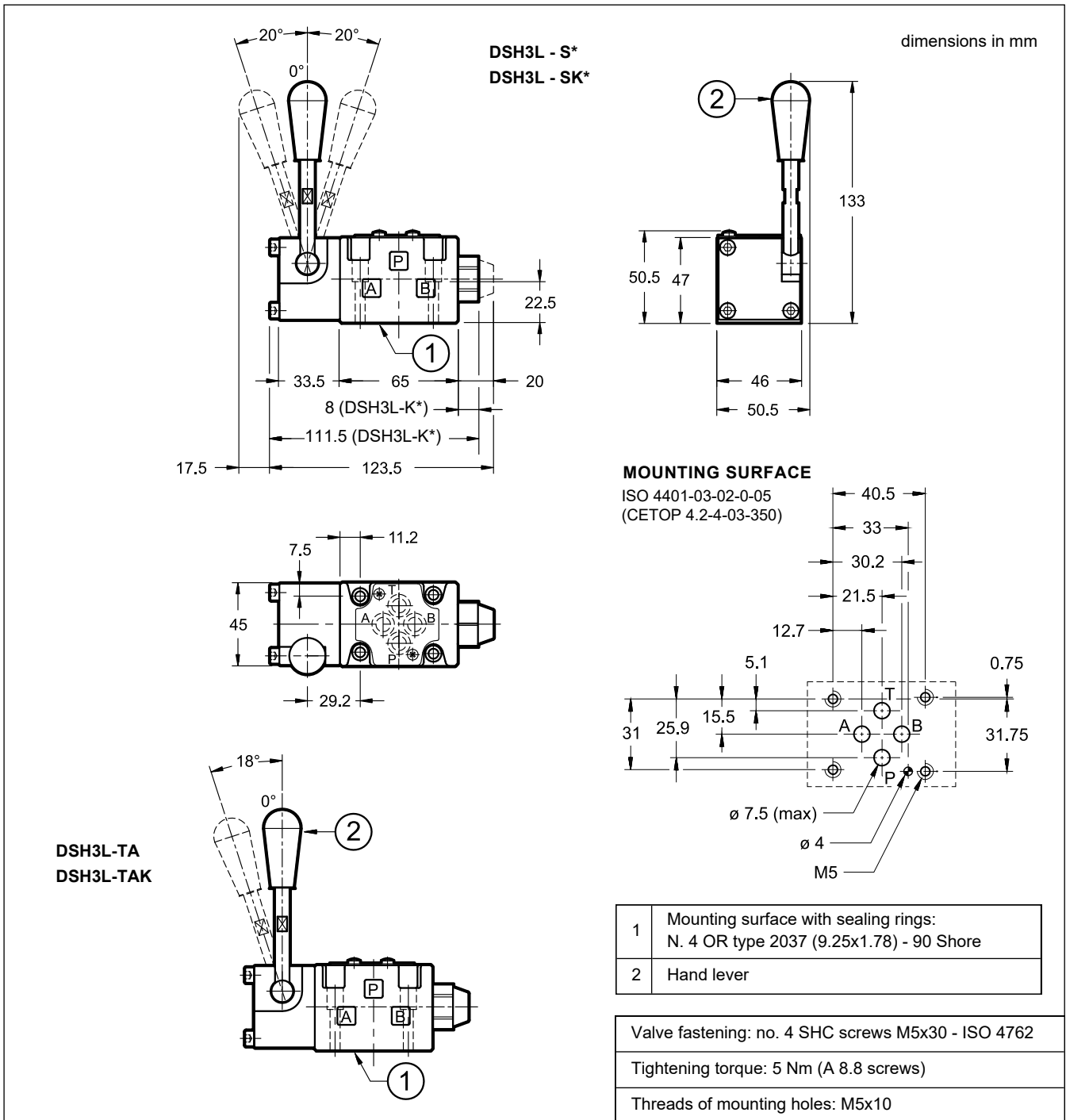

8 - SUBPLATES (see catalogue 51 000)

Type with rear ports: PMMD-AI3G
Type with side ports: PMMD-AL3G
P, T, A and B threads: 3/8" BSP