



LINPC-USB*

TEST DEVICE FOR VALVES WITH INTEGRATED ELECTRONICS

SERIES 31

OPERATING PRINCIPLE

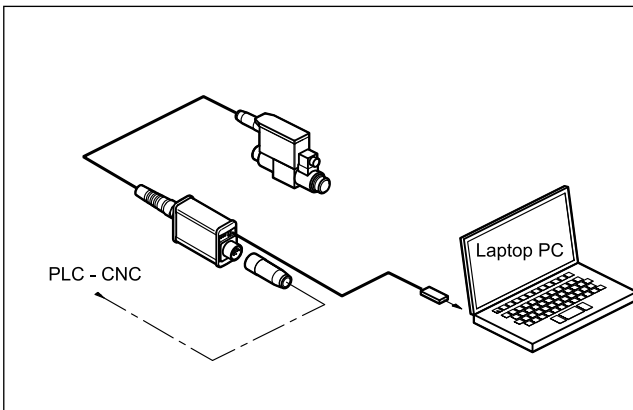

- The kit contains a test device with embedded cable to connect on the valve side, a USB cable for PC connection and a galvanic isolator. The dedicated software is available for download from our web site.
- The devices are suitable for troubleshooting and functional testing of Duplomatic proportional valves for open loop (type G, GH) and closed loop (type J, JH), series 20, 30-33, and for IO-Link or CANBus valves type L and JL.
- The software allows to check settings, diagnostics and permits to modify the standard parameter settings made in factory, adapting it to your system.
- No additional power supply is required: the devices use the supply source coming from the system cable.

TECHNICAL CHARACTERISTICS

Power supply	V DC	24 (19 ÷ 30)
Current consumption	mA	50
Valve side connection:	LINPC-USB5 LINPC-USB7 LINPC-USB12	5 poles M12 6 poles + PE type MIL-C-5015-G (DIN 43563) 11 poles + PE (DIN 43651)
PC side connection		USB 2.0 cable
Electromagnetic compatibility (EMC)		according to 2014/30/EU EN 61000-6-4 (emissions) EN 61000-6-2 (immunity)
Housing dimensions	mm	104x63x40 + 2000 outgoing cable
Operating temperature range	°C	-20 / +60
Protection degree		IP 20

1 - IDENTIFICATION CODE

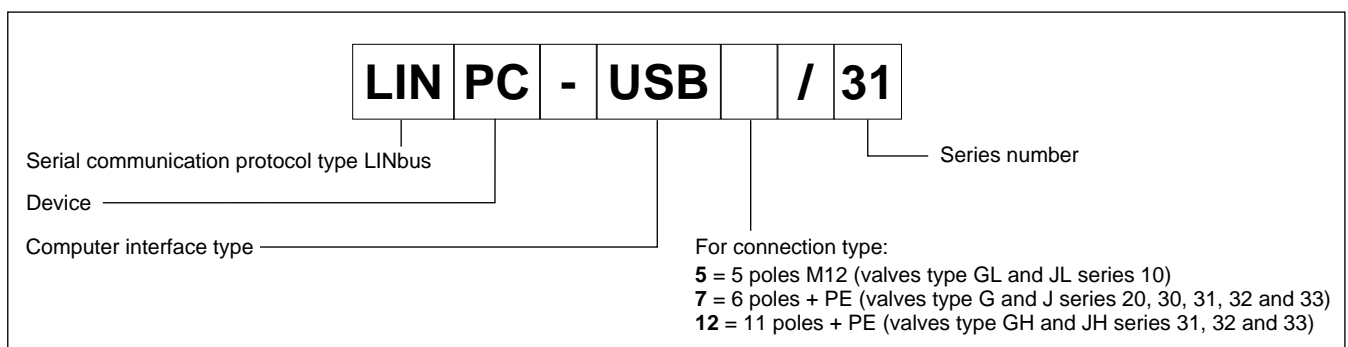



LINPC-USB*

SERIES 31

2 - DESCRIPTION

The device acts as interface between the PC and the valve on-board electronics. It allows the customization of the parameters via software and diagnostics and troubleshooting, by means of the internal monitors available in the software (EBC for series 30, 31, 32 and 33; EWMPC for series 20).

The kit includes:

- test device with embedded cable to be connected to the valve
- USB Cable 2.0 A - Male to Micro B (3 m).
- Galvanic isolator USB 2.0



WARNING! The LINPC USB connector is not galvanically isolated. Always use the galvanic isolator supplied with the kit.

Software and user manual are available for download at www.diplomatic.com. More details on device operation are available in the Software Manual.

The EBC software is compliant with Windows OS 7, 8 and 10.

3 - NOTES OF USE

By connecting the LINPC device to a valve the monitor signal is cut-off to allow LINbus communication (pin 4 in LINPC-USB5, pin F in LINPC-USB7, pin 6 in LINPC-USB12).

This function can be managed via software.

For bench use, always make sure that the wiring in use corresponds to that of the valve to be connected.

The use of USB cables longer than 3 meters leads to a decline in communication quality. It is recommended to use the cable supplied with the kit.

4 - LED

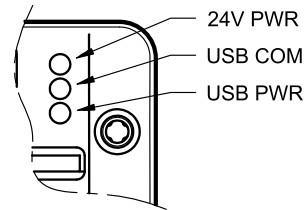

function	description
24V PWR (24V powered)	Main power supply 24V green indicates the device is powered by 24 V source coming from the system.
USB COM	USB communication red = [TX] transmission green = [RX] receiving
USB PWR (USB powered)	USB supply yellow indicates that the USB section is powered.

5 - BLOCK DIAGRAMS

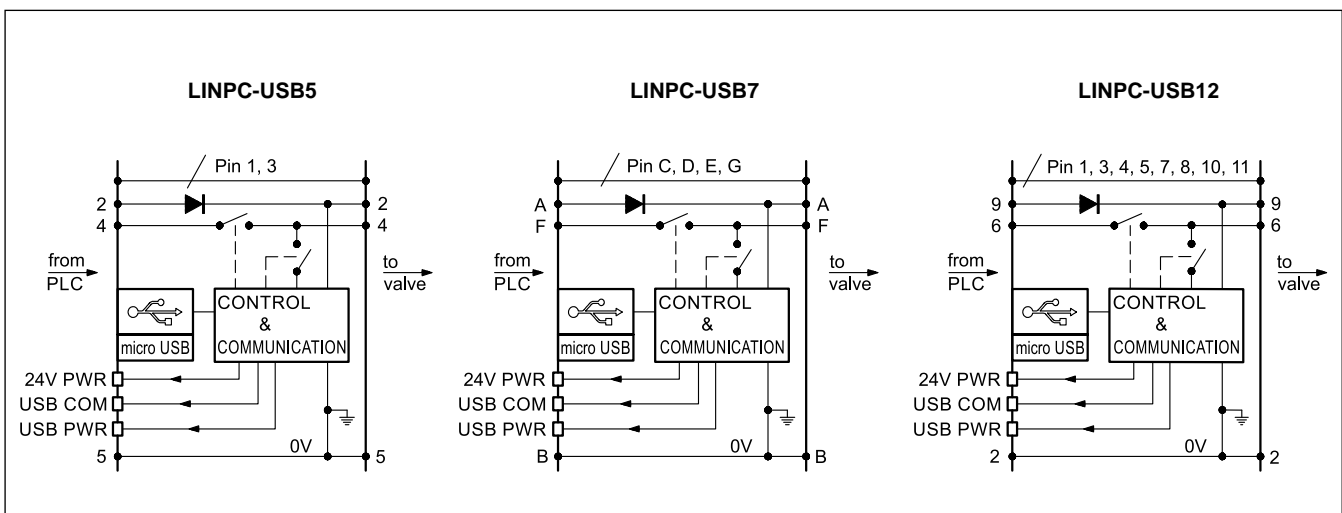



6 - OVERALL DIMENSIONS

6.1 - LINPC-USB5

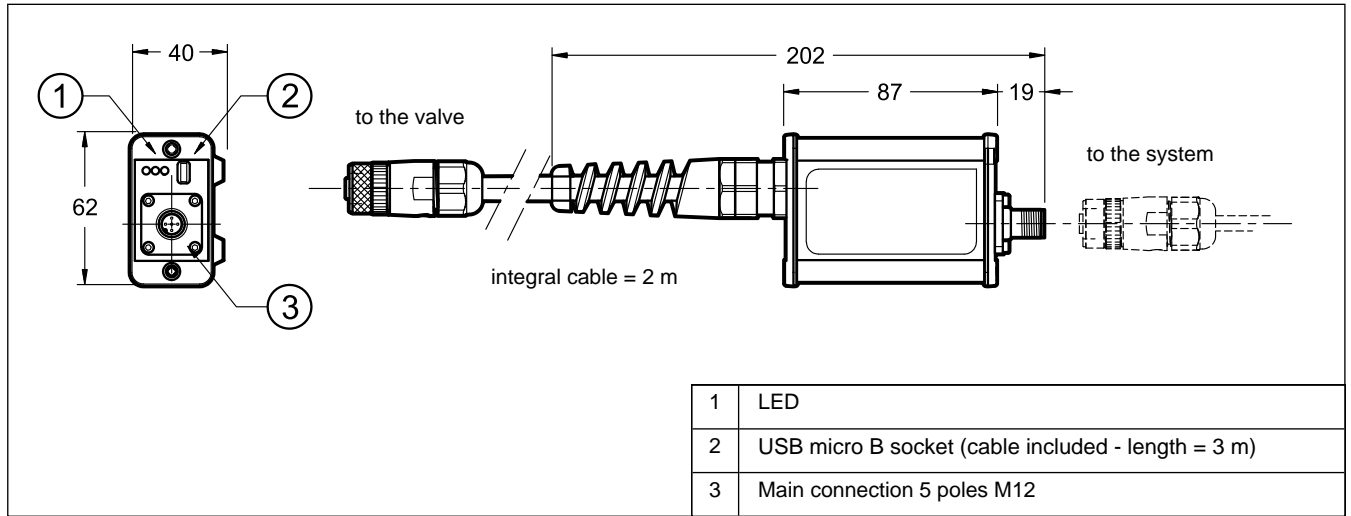

6.2 - LINPC-USB7

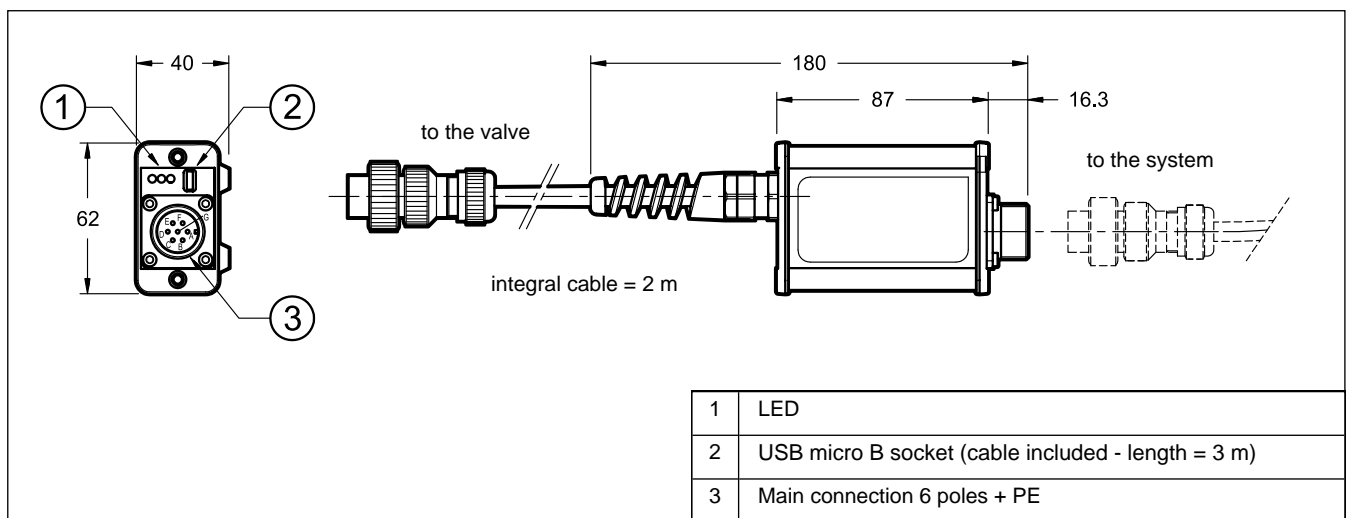

6.3 - LINPC-USB12

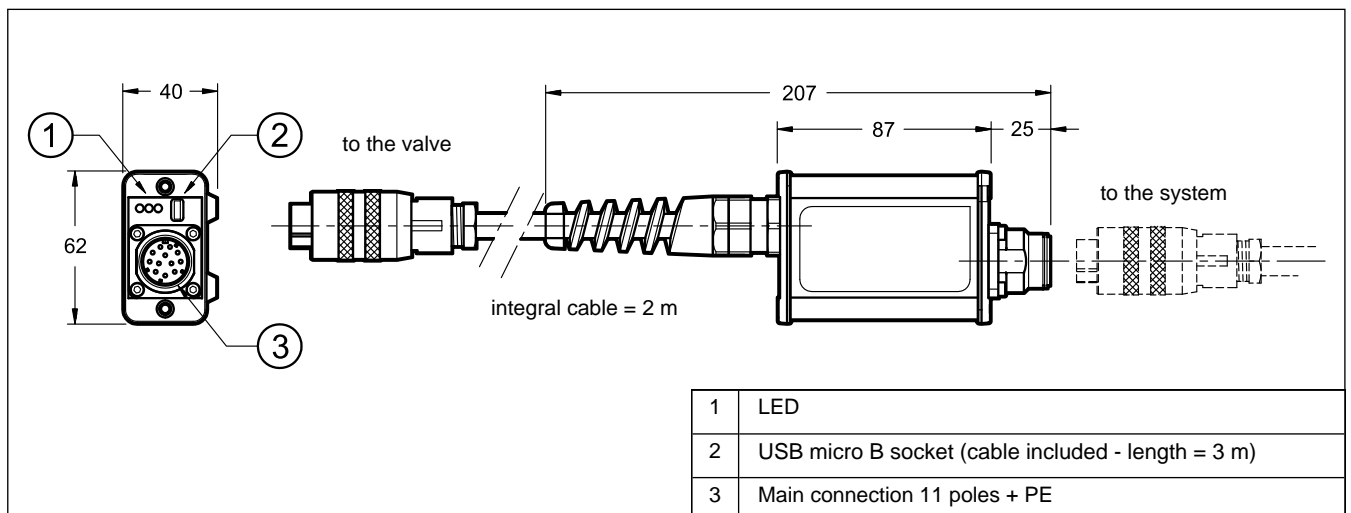



LINPC-USB*

SERIES 31

DUPLOMATIC
MOTION SOLUTIONS
*a member of **DAIKIN** group*

DUPLOMATIC MS Spa

via Mario Re Depaulini, 24 | 20015 Parabiago (MI) | Italy

T +39 0331 895111 | E vendite.ita@duplomatic.com | sales.exp@duplomatic.com
duplomaticmotionsolutions.com